



OUR GLOBAL
COMPETENCE
CENTRES

 APOLLO DISPLAY
TECHNOLOGIES



 DISTEC



 DISPLAY
TECHNOLOGY



Datasheet

Disea

ZW-T024LQS-01

DE-06-003

PRODUCT SPECIFICATIONS

For Customer: _____

: APPROVAL FOR SPECIFICATION

Customer Model No.: _____

: APPROVAL FOR SAMPLE

Module No.: ZW-T024LQS-01

Date : 2017-08-31

Table of Contents

No.	Item	Page
1	Cover Sheet(Table of Contents)	
2	Revision Record	
3	General Specifications	
4	Outline Drawing	
5	Absolute Maximum Ratings	
6	Electrical Specifications	
7	Optical Characteristics	
8	Reliability Test Items and Criteria	
9	Precautions for Use of LCD Modules	

For Customer's Acceptance:

Approved By	Comment

PREPARED John	CHECKED Techshu	VERIFIED BY QA DEPT	VERIFIED BY R&D DEPT Dmjiaing
------------------	--------------------	---------------------	----------------------------------

3. General Specifications

ZW-T024LQS-01 is a TFT-LCD module. It is composed of a TFT-LCD panel, driver IC, FPC, a back light unit. The 2.4'' display area contains 240 x 320pixels and can display up to 262K colors. This product accords with RoHS environmental criterion.

Item	Contents	Unit	Note
LCD Type	TFT/Transflective	-	
Display color	262K		
Viewing Direction	Full viewing angle	O'Clock	
Operating temperature	-20~+70	°C	
Storage temperature	-30~+80	°C	
Module size	42.92x60.26x2.45	mm	
Active Area(W×H)	36.72X48.96	mm	
Number of Dots	240X320	dots	
Controller	ST7789V	-	
Power Supply Voltage	2.8	V	
Backlight	4-LEDs (white)	pcs	
Weight	---	g	
Interface	MCU-16bit	-	

Note 1: Color tune is slightly changed by temperature and driving voltage.

Note 2: Without FPC and Solder.

4.Outline.Drawing

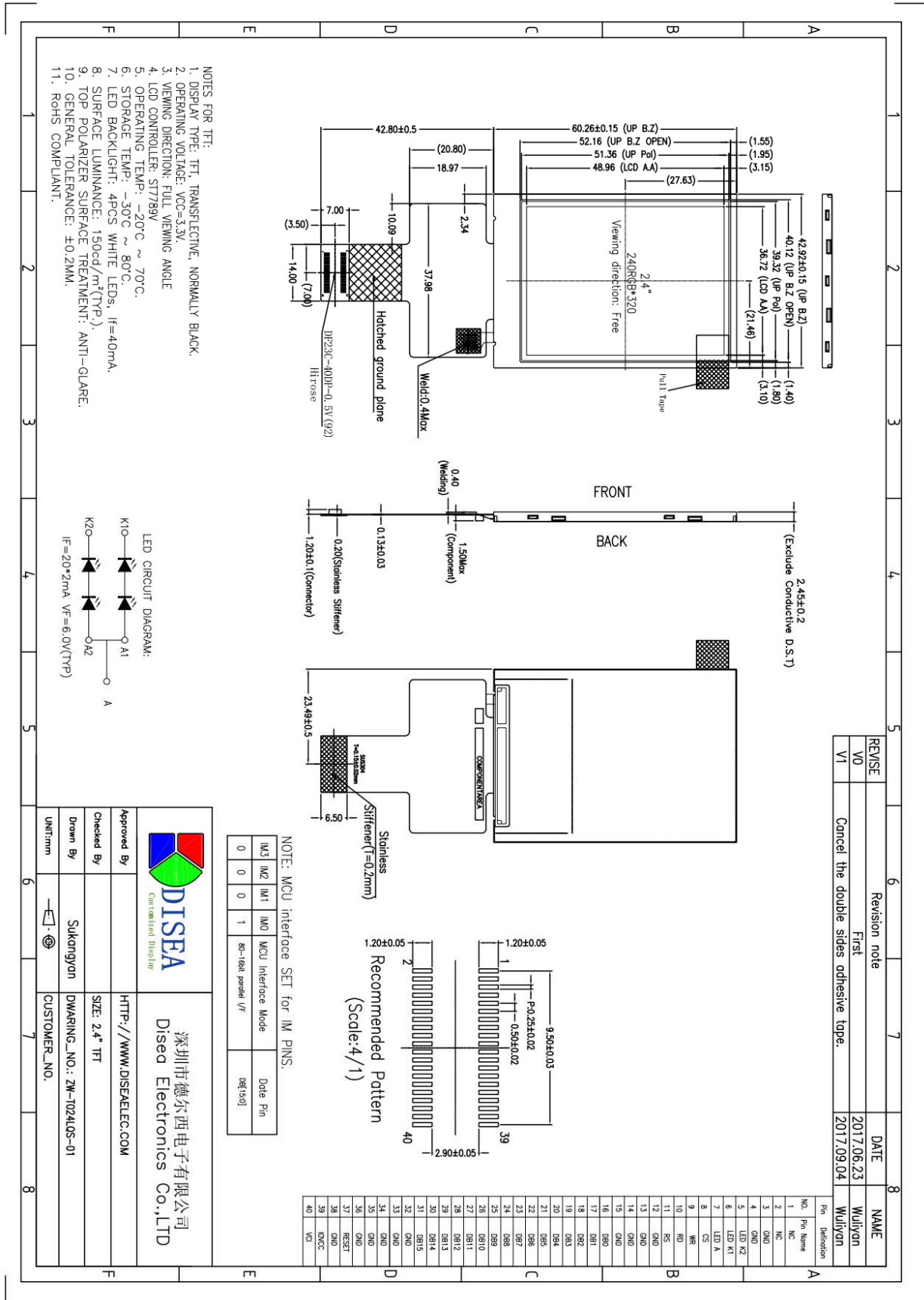

5. Absolute Maximum Ratings($T_a=25^\circ\text{C}$)

5.1 Electrical Absolute Maximum Ratings.($V_{ss}=0\text{V}$, $T_a=25^\circ\text{C}$)

Item	Symbol	Min.	Max.	Unit	Note
Power Supply Voltage	IOV_{CC}	-0.3	3.6	V	1, 2
	VCI	-0.3	3.6	V	

Notes:

1. If the module is above these absolute maximum ratings. It may become permanently damaged. Using the module within the following electrical characteristic conditions are also exceeded, the module will malfunction and cause poor reliability.
2. $V_{CI} > V_{SS}$ must be maintained.
3. Please be sure users are grounded when handing LCD Module.

5.2 Environmental Absolute Maximum Ratings.

Item	Storage		Operating		Note
	MIN.	MAX.	MIN.	MAX.	
Ambient Temperature	-30°C	80°C	-20°C	70°C	1,2
Humidity	-	-	-	-	3

1. The response time will become lower when operated at low temperature.
2. Background color changes slightly depending on ambient temperature.
The phenomenon is reversible.
3. $T_a < 40^\circ\text{C}$:85%RH MAX.

$T_a \geq 40^\circ\text{C}$:Absolute humidity must be lower than the humidity of 85%RH at 40°C .

6. Electrical Specifications and Instruction Code

6.1 Electrical characteristics($V_{SS}=0V, T_a=25^\circ C$)

Parameter		Symbol	Condition	Min	Typ	Max	Unit	Note
Power supply		V _{CI}	T _a =25°C	2.4	2.8	3.6	V	
		IOVCC		1.65	1.8	3.6	V	
Input voltage	'H'	V _{IH}	V _{CI} =3.3V	0.8V _{CI}	-	V _{CI}	V	
	'L'	V _{IL}	V _{CI} =3.3V	0	-	0.2V _{CI}	V	
Current Consumption		I _{CC1}	Normal mode	-	-	-	mA	1
		I _{CC2}	Sleep mode	-	-	-	mA	1

Note:

1: Tested in 1×1 chessboard pattern.

6.2 LED backlight specification($V_{SS}=0V, T_a=25^\circ C$)

Item	Symbol	Condition	Min	Typ	Max	Unit	Note
Supply voltage	V _f	I _f =40mA	5.0	6.0	7.0	V	
Uniformity	Δ Bp	I _f =40mA	75	-	-	%	
Life Time	time	I _f =40mA	-	30000	-	hours	1

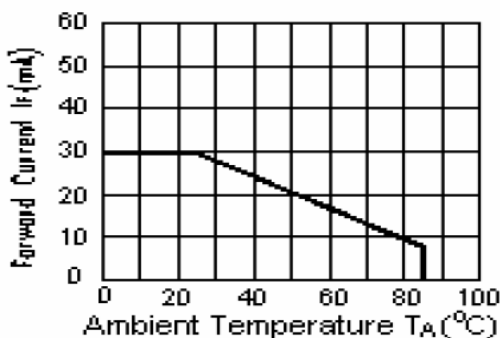

6.3 Interface signals

Pin No.	Symbol	I/O	Function
1-2	NC	-	NO Connection
3-4	GND	P	Ground.
5-6	LEDK2-LEDK1	P	Power Supply For LED backlight(-)
7	LEDA	P	Power Supply For LED backlight(+)
8	CS	I	Chip Select Signal
9	WR	I	Server As A Write Signal And Write Data At The Rising Edge
10	RD	I	Server As A Read Signal And Read Data At The Low Level
11	RS	I	The signal for command or parameter select under parallel Select under parallel mode: Low:command High:parameter
12-15	GND	P	Ground.
16-31	D0-D15	I	16-Data bus.
32-36	GND	P	Ground.
37	RESET	I	Reset Pin.
38	GND	P	Ground.
39	IOVCC	P	Power supply for I/O system
40	VCI	P	Power supply for analog.

6.4 8080 Series MCU Parallel Interface Characteristics: 18/16/9/8-bit Bus

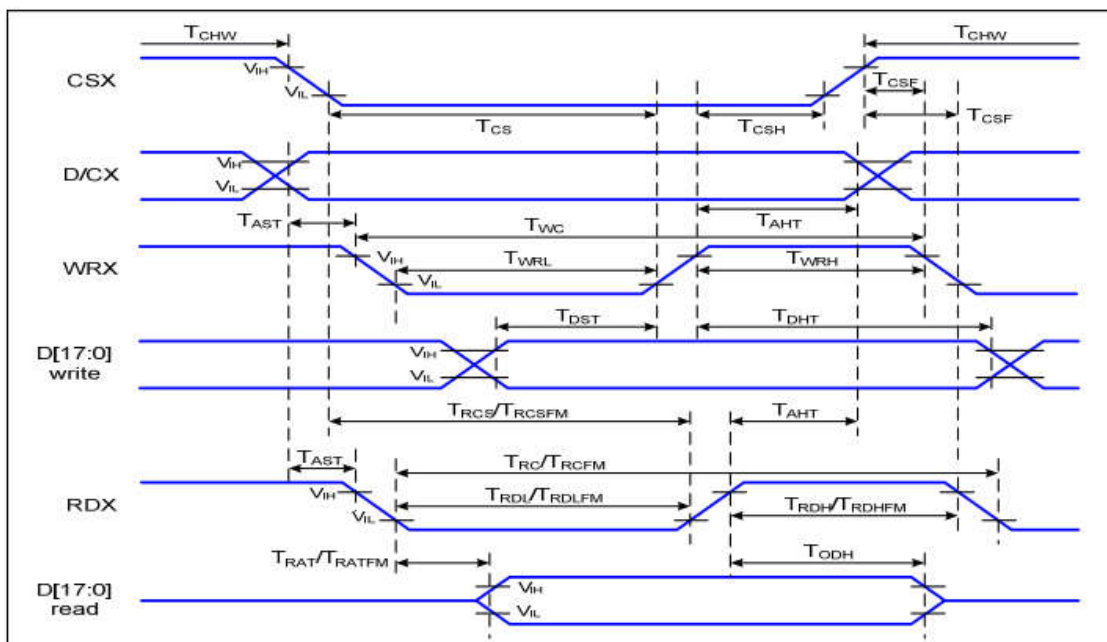

Figure 1 Parallel Interface Timing Characteristics (8080-Series MCU Interface)

$VDDI=1.65$ to $3.3V$, $VDD=2.4$ to $3.3V$, $AGND=DGND=0V$, $T_a = -30$ to 70 °C

Signal	Symbol	Parameter	Min	Max	Unit	Description
D/CX	T_{AST}	Address setup time	0		ns	-
	T_{AHT}	Address hold time (Write/Read)	10		ns	
CSX	T_{CHW}	Chip select "H" pulse width	0		ns	-
	T_{CS}	Chip select setup time (Write)	15		ns	
	T_{RCS}	Chip select setup time (Read ID)	45		ns	
	T_{RCSFM}	Chip select setup time (Read FM)	355		ns	
	T_{CSF}	Chip select wait time (Write/Read)	10		ns	
	T_{CSH}	Chip select hold time	10		ns	
WRX	T_{WC}	Write cycle	66		ns	
	T_{WRH}	Control pulse "H" duration	15		ns	
	T_{WRL}	Control pulse "L" duration	15		ns	
RDX (ID)	T_{RC}	Read cycle (ID)	160		ns	When read ID data
	T_{RDH}	Control pulse "H" duration (ID)	90		ns	
	T_{RDL}	Control pulse "L" duration (ID)	45		ns	
RDX (FM)	T_{RCFM}	Read cycle (FM)	450		ns	When read from frame memory
	T_{RDHFM}	Control pulse "H" duration (FM)	90		ns	
	T_{RDLFM}	Control pulse "L" duration (FM)	355		ns	
D[17:0]	T_{DST}	Data setup time	10		ns	For CL=30pF
	T_{DHT}	Data hold time	10		ns	
	T_{RAT}	Read access time (ID)		40	ns	
	T_{RATFM}	Read access time (FM)		340	ns	
	T_{ODH}	Output disable time	20	80	ns	

Table 4 8080 Parallel Interface Characteristics

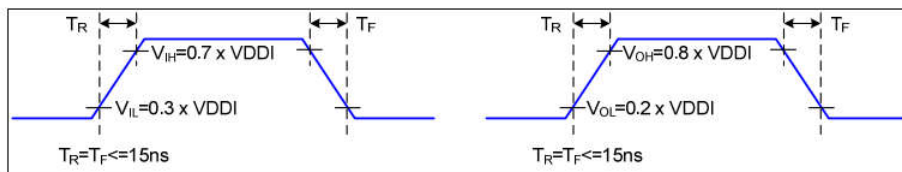

Figure 2 Rising and Falling Timing for I/O Signal

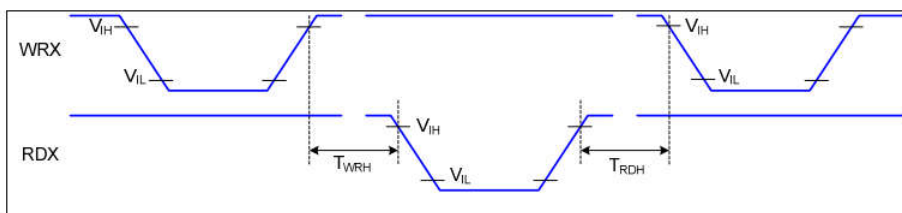

Figure 3 Write-to-Read and Read-to-Write Timing

Note: The rising time and falling time (T_r , T_f) of input signal and fall time are specified at 15 ns or less. Logic high and low levels are specified as 30% and 70% of VDDI for Input signals.

7. Optical Characteristics

Item	Symbol	Condition	Min.	Typ.	Max.	Unit	Note	
Brightness (with TP)	Bp	$\theta=0^\circ$ $\Phi=0^\circ$	100	150	-	Cd/m ²	1	
Uniformity	$\triangle Bp$		75	-	-	%	1,2	
Viewing Angle	3:00	Cr \geq 10	60	80	-	Deg	3	
	6:00		60	80	-			
	9:00		60	80	-			
	12:00		60	80	-			
Contrast Ratio	Cr	$\theta=0^\circ$ $\Phi=0^\circ$	200	300	-	-	4	
Response Time	T _r +T _f		-	25	50	ms	5	
		-	ms					
Color of CIE Coordinate	W	x	$\theta=0^\circ$ $\Phi=0^\circ$	-0.05	+0.05	0.28	-	1,6
		y				0.33	-	
	R	x				0.51	-	
		y				0.34	-	
	G	x				0.31	-	
		y				0.56	-	
	B	x				0.15	-	
		y				0.14	-	
NTSC Ratio	S	50	60	-	%			

Note: The parameter is slightly changed by temperature, driving voltage and materiel

Note 1: The data are measured after LEDs are turned on for 5 minutes. LCM displays full white. The brightness is the average value of 5 measured spots. Measurement equipment BM-7 (Φ5mm)

Measuring condition:

- Measuring surroundings: Dark room.
- Measuring temperature: Ta=25 °C.
- Adjust operating voltage to get optimum contrast at the center of the display.

Measured value at the center point of LCD panel after more than 5 minutes while backlight turning on.

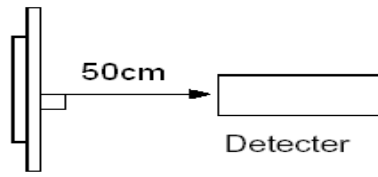

Note 2: The luminance uniformity is calculated by using following formula.

$$\Delta Bp = Bp (\text{Min.}) / Bp (\text{Max.}) \times 100 (\%)$$

$Bp (\text{Max.})$ = Maximum brightness in 5 measured spots

$Bp (\text{Min.})$ = Minimum brightness in 5 measured spots.

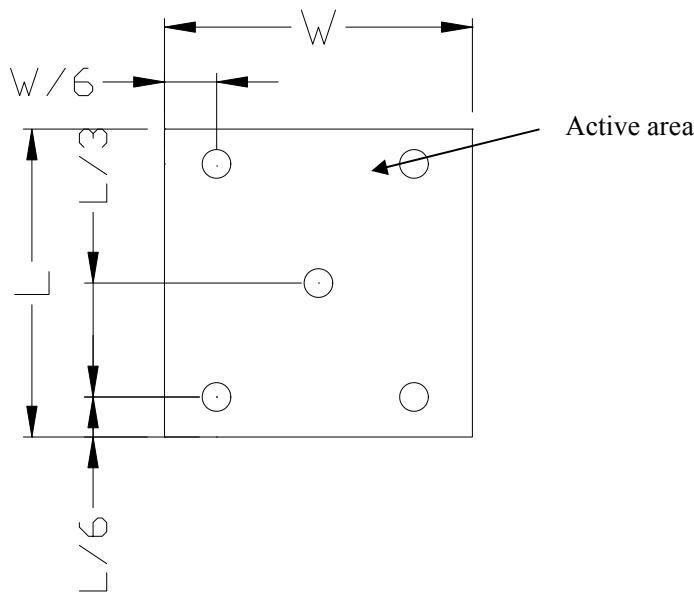

Note 3: The definition of viewing angle:

Refer to the graph below marked by ϑ and Φ

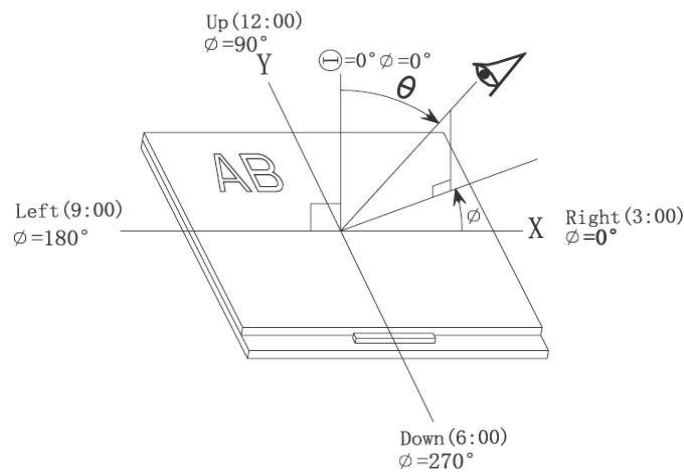

Note 4: Definition of contrast ratio.(Test LCD using DMS501)

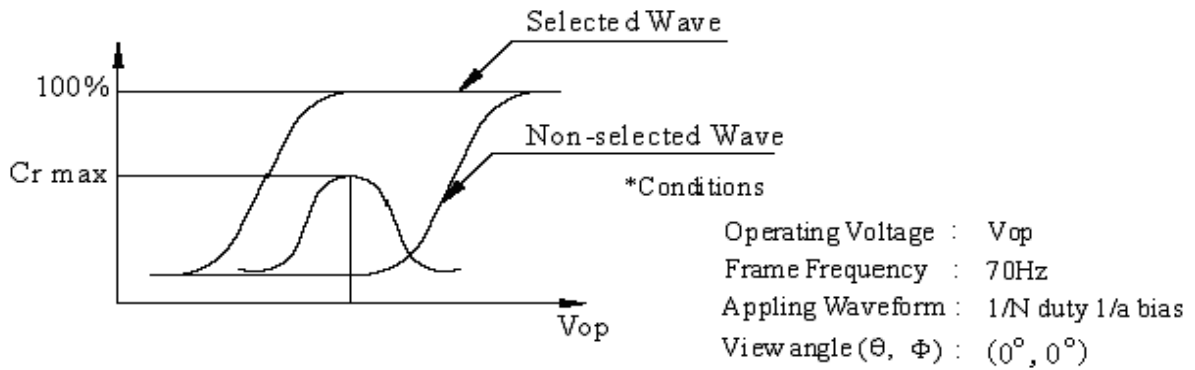

$$\text{Contrast ratio}(Cr) = \frac{\text{Brightness of selected dots}}{\text{Brightness of non-selected dots}}$$

Note 5: Definition of Response time. (Test LCD using DMS501):

The output signals of photo detector are measured when the input signals are changed from "black" to "white"(falling time) and from "white" to "black"(rising time), respectively. The response time is defined as the time interval between the 10% and 90% of amplitudes. Refer to figure as below.

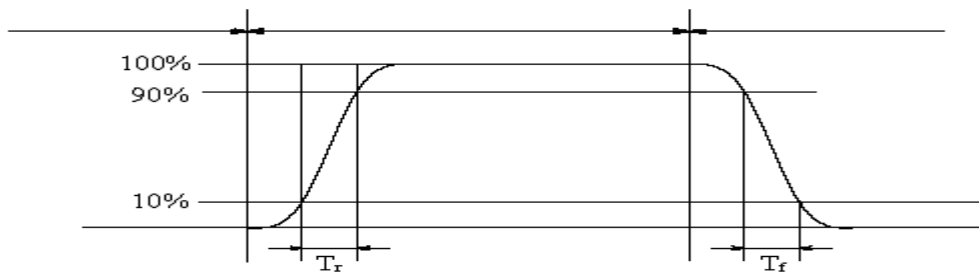

The definition of response time

Note 6: Definition of Color of CIE Coordinate and NTSC Ratio.

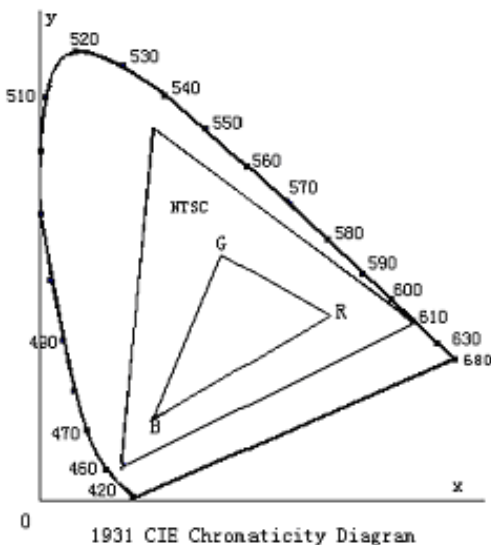

Color gamut:

$$S = \frac{\text{area of RGB triangle}}{\text{area of NTSC triangle}} \times 100\%$$

Note 7: Definition of cross talk.

$$\text{Cross talk ratio}(\%) = \frac{|\text{pattern A Brightness} - \text{pattern B Brightness}|}{\text{pattern A Brightness}} \times 100$$

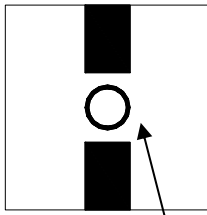

Pattern A

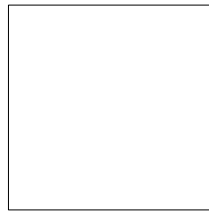

Pattern B

Measurement point(center)

Electric volume value=3F+/-3Hex

8. Reliability Test Items and Criteria

No	Test Item	Test condition	Criterion
1	High Temperature Storage	80°C±2°C 96H Restore 2H at 25°C Power off	1. After testing, cosmetic and electrical defects should not happen. 2. Total current consumption should not be more than twice of initial value.
2	Low Temperature Storage	-30°C±2°C 96H Restore 2H at 25°C Power off	
3	High Temperature Operation	70°C±2°C 96H Restore 2H at 25°C Power on	
4	Low Temperature Operation	-20°C±2°C 96H Restore 4H at 25°C Power on	
5	High Temperature/Humidity Operation	60°C±2°C 90%RH 96H Power on	
6	Temperature Cycle	-30°C → 80°C 30min 5min 30min after 5 cycle, Restore 2H at 25°C Power off	
7	Vibration Test	10Hz~150Hz, 100m/s ² , 120min	Not allowed cosmetic and electrical defects.
8	Shock Test	Half- sine wave, 300m/s ² , 11ms	

Note: Operation: Supply 2.8V for logic system.

The inspection terms after reliability test, as below

ITEM	Inspection
Contrast	CR>50%
IDD	IDD<200%
Brightness	Brightness>60%
Color Tone	Color Tone+/-0,05

9. Precautions for Use of LCD Modules

9.1 Handling Precautions

9.1.1 *The display panel is made of glass. Do not subject it to a mechanical shock by dropping it from a high place, etc.*

9.1.2 *If the display panel is damaged and the liquid crystal substance inside it leaks out, be sure not to get any in your mouth, if the substance comes into contact with your skin or clothes, promptly wash it off using soap and water.*

9.1.3 *Do not apply excessive force to the display surface or the adjoining areas since this may cause the color tone to vary.*

9.1.4 *The polarizer covering the display surface of the LCD module is soft and easily scratched. Handle this polarizer carefully.*

9.1.5 *If the display surface is contaminated, breathe on the surface and gently wipe it with a soft dry cloth. If still not completely clear, moisten cloth with one of the following solvents:*

— Isopropyl alcohol — Ethyl alcohol

Solvents other than those mentioned above may damage the polarizer. Especially, do not use the following:

— Water — Ketone — Aromatic solvents

9.1.6 *Do not attempt to disassemble the LCD Module.*

9.1.7 *If the logic circuit power is off, do not apply the input signals.*

9.1.8 *To prevent destruction of the elements by static electricity, be careful to maintain an optimum work environment.*

a. Be sure to ground the body when handling the LCD Modules.

b. Tools required for assembly, such as soldering irons, must be properly ground.

c. To reduce the amount of static electricity generated, do not conduct assembly and other work under dry conditions.

d. The LCD Module is coated with a film to protect the display surface. Be care when peeling off this protective film since static electricity may be generated.

9.2 Storage precautions

9.2.1 *When storing the LCD modules, avoid exposure to direct sunlight or to the light of fluorescent lamps.*

9.2.2 *The LCD modules should be stored under the storage temperature range. If the LCD modules will be stored for a long time, the recommend condition is:*

Temperature : 0 °C ~ 40 °C

Relatively humidity: ≤80%

9.2.3 *The LCD modules should be stored in the room without acid, alkali and harmful gas.*

9.3 *The LCD modules should be no falling and violent shocking during transportation, and also should avoid excessive press, water, damp and sunshine.*

END

Our company network supports you worldwide with offices in Germany, Austria, Switzerland, the UK and the USA. For more information please contact:

Headquarters

Germany



FORTEC Elektronik AG

Lechwiesenstr. 9
86899 Landsberg am Lech

Phone: +49 8191 91172-0
E-Mail: sales@forteca.de
Internet: www.forteca.de

Fortec Group Members

Austria



FORTEC Elektronik AG

Office Vienna

Nuschinggasse 12
1230 Wien

Phone: +43 1 8673492-0
E-Mail: office@fortec.at
Internet: www.fortec.at

Germany



Distec GmbH

Augsburger Str. 2b
82110 Germering

Phone: +49 89 894363-0
E-Mail: info@distec.de
Internet: www.distec.de

Switzerland



ALTRAC AG

Bahnhofstraße 3
5436 Würenlos

Phone: +41 44 7446111
E-Mail: info@altrac.ch
Internet: www.altrac.ch

United Kingdom



Display Technology Ltd.

Osprey House, 1 Osprey Court
Hichingbrooke Business Park
Huntingdon, Cambridgeshire, PE29 6FN

Phone: +44 1480 411600
E-Mail: info@displaytechnology.co.uk
Internet: www.displaytechnology.co.uk

USA



Apollo Display Technologies, Corp.

87 Raynor Avenue,
Unit 1 Ronkonkoma,
NY 11779

Phone: +1 631 5804360
E-Mail: info@apolloDisplays.com
Internet: www.apolloDisplays.com