

DATASHEET



 **DISTEC**  
A FORTEC GROUP MEMBER

POS-LINE 21.5

SIMPLY INTEGRATE  
VISUALISE YOUR CONTENT

# Panel and housing

## POS-Line 21.5 monitor

Panel Diagonal	[mm] / [Inch]	546.86/ 21.5
Type		Open -frame monitor with 2 mounting brackets (various bezels, true-flat glass and touch solutions are available under options)
Resolution	[Pixel]	1920 x 1080 FHD
Luminance (center)	[cd/m <sup>2</sup> ]	300
Viewing angle	[°]	178 h / 178 v
Backlight		LED
Active area (H/V)	[mm]	476.6 x 268.1
Number of colors	[M]	16.7
Contrast ratio		5000:1
Response time (on/off)	[ms]	25
Pixel class		ISO 9241-307 (pixel error class II)
Life time back light until reaching half brightness	[h]	50.000
Continuous operation	[hh/d]	24/ 7
Mounting	[mm]	VESA 200 x 100
Storage temperature	[°C] / [°F]	-20 ~ 60/ -4 ~ 140
Storage humidity	[%]	5 ~ 90 (non condensing)
Operating humidity	[%]	5 ~ 90 (non condensing)
Panel orientation		Landscape and Portrait
Location of connectors		Landscape: bottom Portrait: left (front view)
Location of OSD buttons		Landscape: top Portrait: right (front view)
Housing		Powdered Aluminium, black RAL 9005
IP grade		IP 65 on the front if option - TrueFlat glass or - TrueFlat touch
Conformity		CE, FCC Class A, EU-RoHS
Packaging		single packaging, up to 4 via parcel service, from 5 units on pallet
Package contents		Safety instructions



Open frame monitor including two standard brackets and all possible optional mounting brackets



All figures are typical values. The real values of the panel may vary. The optical characteristics are determined after the panel has been „ON“ for approximately 30 minutes at an ambient temperature of 25° C (77° F).

Life time of the backlight is defined as the time to take until the brightness reduces to 50% of its original value.

Copyright 2021 Distec GmbH. Information in the document is subject to change without prior notice.

# VGA, HDMI, DisplayPort

## POS-Line 21.5 Video PME

Order number		DS-91-786
Interfaces		1 x VGA, 1 x HDMI, 1 x DisplayPort, 1 x Audio Line-Out, 1 x USB-Remote
Operating temperature	[°C/ F°]	0 ~ 50/ 32 ~ 122
Power supply	[V]	12
Power consumption (typ.)	[Watt]	22
Weight	[kg/ lb]	3.2/ 7.05
Dimensions (W x H x D)	[mm/ inch]	514 x 319 x 54 20.24 x 12.56 x 2.13
Package contents		SVGA cable

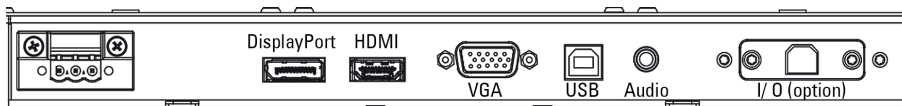

# Network Mediaplayer

## POS-Line 21,5 VideoPoster

Order number		DS-91-787
Interfaces		1 x LAN, 2 x USB, 1 x HDMI in, 1 x Line out, 1 x microSD card slot
Operating temperature	[°C/ F°]	0 ~ 45/ 32 ~ 113
Power supply	[V]	12
Power consumption (typ.)	[Watt]	23
Weight	[kg/ lb]	3.4/ 7.49
Dimensions (W x H x D)	[mm/ inch]	514 x 319 x 54 20.24 x 12.56 x 2.13
Package contents		USB stick 8GB

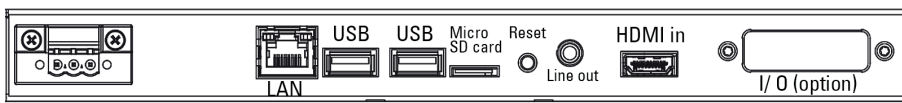

# Raspberry® IoT controller

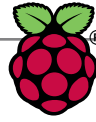

## POS-Line 21.5 IoT

Order number		DS-91-821
Order number OS		DS-60-859
Interfaces		1 x LAN, 2 x USB, 1 x HDMI, 1 x Line out, 1 x microSD card slot
Operating temperature	[°C/ F°]	0 ~ 45/ 32 ~ 113
Power supply	[V]	12
Power consumption (typ.)	[Watt]	23
Weight	[kg/ lb]	3.4/ 7.49
Dimensions (W x H x D)	[mm/ inch]	514 x 319 x 54 20.24 x 12.56 x 2.13

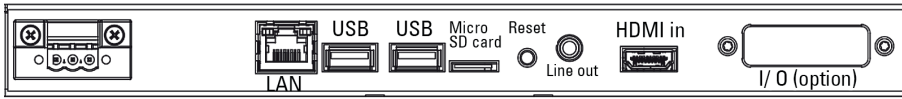

# PC Intel® Celeron®



## POS-Line 21.5 IQ Celeron

Order number		DS-92-182
Interfaces		2 x Gigabit LAN, 4 x USB 3.0, 1 x HDMI, 1 x RS232/422/485, 1 x RS232 (optional)
PC		CPU: Intel® Celeron® J3455 (1,5GHz/2,3GHz), RAM: 4 GB DDR3L, Storage: min. 120 GB mSATA
Fan		no
Operating temperature	[°C/ F°]	0 ~ 45/ 32 ~ 113
Power supply	[V]	12 - 26
Power consumption (typ.)	[Watt]	ca. 28
Weight	[kg/ lb]	ca. 3.3/ 7.27
Dimensions (W x H x D)	[mm/ inch]	514 x 319 x 54 20.24 x 12.56 x 2.13

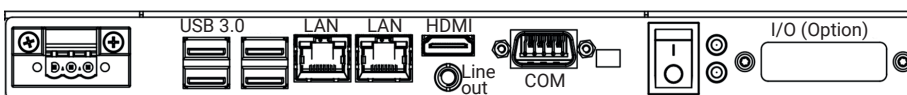

## Glass\*

Order number		DS-91-796	DS-91-757
Name		Safety glass	TrueFlat glass
Glass		Safety glass TSG, 3 mm anti glare	Safety glass TSG, 3 mm anti glare, black passepartout
Can be combined with		Front bezel, Front plate	–
IP protection	front/ rear	IP 64 (only with bezel or plate)/ IP 20	IP 65/ IP 20
Weight	[kg/ lb]	1.20/ 2.65	1.80/ 3.97
Dimensions of monitor with option	[W x H x D] [mm/ inch]	514 x 319 x 54 20.24 x 12.56 x 2.13	538 x 343 x 60 21.18 x 13.50 x 2.36

## Touches\*

Order number		DS-91-761	DS-91-762
Name		PCAP touch	TrueFlat PCAP touch
Glass		Safety glass TSG, 3 mm anti glare	
Touch points		10	
Touch technology		Projected capacitive	
Can be combined with		Front bezel, Front plate	–
IP protection	front/ rear	IP 64 (only with bezel or plate)/ IP 20	IP 65/ IP 20
Available for controller		Video PME, IoT, IQ Atom	
Weight	[kg/ lb]	1.20/ 2.65	1.80/ 3.97
Dimensions of monitor with option	[W x H x D] [mm/ inch]	514 x 319 x 54 20.24 x 12.56 x 2.13	538 x 343 x 60 21.18 x 13.50 x 2.36

## Bezel/ Plate

Order number		DS-91-689	DS-91-752
Name		Front bezel	Front plate
Finish		Steel, powdered, black RAL 9005	Aluminum, powdered, black RAL 9005
Can be combined with		PCAP touch, Safety glass	
IP protection	front/ rear	IP64 (in combination with glass/ touch) otherw. IP20/ IP20	
Weight	[kg/ lb]	0.70/ 1.54	
Dimensions of monitor with option	[W x H x D] [mm/ inch]	517 x 322 x 55.5 20.35 x 12.68 x 2.18	538 x 343 x 58.5 21.18 x 13.50 x 2.30

## Options



Safety glass and touch are options for the open frame chassis. It covers and protects the TFT-panel.



TrueFlat glass is a safety glass with round corners and passepartout for the open frame chassis. TrueFlat P-CAP touch is a TrueFlat glass with a laminated P-CAP touch at the backside.

\*Cover glass and touches will reduce monitor brightness.



Front bezel is a metal bezel for the open frame chassis and VESA mount.



Front plate is a metal frame for front mount applications with mounting brackets.

## Mounting/ RS 232

Order number	DS-91-797	DS-91-356
Name	VESA adapter plate	Mounting brackets
Description	Adaption from VESA 200 x 100 to VESA 100 x 100	Set of two additional mounting brackets
Can be combined with	with all front options	Open frame, front plate, safety glass, TueFlat glass, PCAP touch, TrueFlat PCAP touch
Available for controller	all	

Order number	DS-91-823
Name	2nd RS 232 port
Can be combined with	with all front options
Available for controller	Intel® Atom board

## Accessories

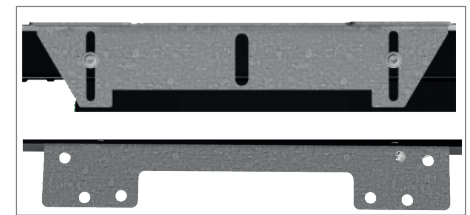
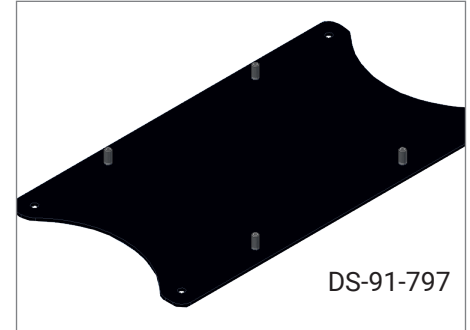

## Power supply

Order number	NT-01-062
Name	Power supply 60 W
Description	12V/ 5A power supply max. op. temperature 45°C
Can be combined with	Video PME, VideoPoster, IoT, IQ Atom,
Power cord EU 1,8 m	DB-07-225
Power cord UK 1,8 m	DB-07-226
Power cord USA 1,8 m	DB-07-238

## Operating systems, Software

Product	Order no.	Product description
WIN 10 IOT	DS-60-899	Embedded operation system 2019 LTSC
Windows 10 Pro. 64 bit DE	DS-60-811	Operation system
Windows 10 Pro. 64 bit EN	DS-60-810	Operation system
WEBPOSTER	DS-60-787	WEBPOSTER embedded Linux

Various accessories are available for POS-Line monitors.

All monitors can be customized according to your specific requirements.

Please contact our sales team if you are interested in product modifications or custom designs.



Contact

Our company network supports you worldwide with offices in Germany, Austria, Switzerland, Great Britain and the USA.  
For more information please contact:

**HEADQUARTER - GERMANY**

**FORTEC** FORTEC Elektronik AG  
ELEKTRONIK AG  
Augsburger Str. 2b  
82110 Germering

Phone +49 89 894363-0  
E-Mail sales@FORTECag.de  
Internet www.FORTECag.de

Designed,  
developed and  
made in Germany

**FORTEC GROUP MEMBERS**

**GERMANY**



Distec GmbH  
Augsburger Str. 2b  
82110 Germering

Phone +49 369207162-0  
E-Mail solution@distec.de  
Internet www.distec.de

**AUSTRIA**



Distec GmbH  
Office Vienna  
Nuschinggasse 12  
1230 Wien

Phone +43 1 8 67 34 92-0  
E-Mail info@distec.de  
Internet www.distec.de

**SWITZERLAND**



ALTRAC AG  
Bahnhofstraße 3  
5436 Würenlos

Phone +41 44 7 44 61 11  
E-Mail info@altrac.ch  
Internet www.altrac.ch

**UNITED KINGDOM**



Display Technology Ltd.  
Osprey House, 1 Sprey Court  
Hichingbrooke Business Park  
Huntingdon, Cambridgeshire  
PE29 6FN

Phone +44 14 80 41 16 00  
E-Mail info@displaytechnology.co.uk  
Internet www.displaytechnology.co.uk

**USA**



Apollo  
Display Technologies, Corp.  
87 Raynor Avenue,  
Unit 1, Ronkonkoma  
NY 11779

Phone +1 6 31 5 80 43 60  
E-Mail info@apollodisplays.com  
Internet www.apollodisplays.com