



# Disea Electronics Co., LTD

E-mail:sales@diseaelec.com    URL:www.diseaelec.com  
ADD: 5F,#3 Building, TianFuAn Industrial park, LeZhuJiao,  
ZhouShi Road,XiXiang Town, BaoAn District, ShenZhen  
City, GuangDong Province , China

## PRODUCT SPECIFICATIONS

For Customer: \_\_\_\_\_

: APPROVAL FOR SPECIFICATION

Customer Model No. \_\_\_\_\_

: APPROVAL FOR SAMPLE

Module No.: ZW-T050GGSA-03

Date : 2022-04-28

### Table of Contents

No.	Item	Page
1	Cover Sheet(Table of Contents)	P1
2	Revision Record	P2
3	General Specifications	P3
4	Outline Drawing	P4
5	Absolute Maximum Ratings	P5
6	Electrical Specifications	P6-P10
7	Optical Characteristics	P11-P14
8	Reliability Test Items and Criteria	P15
9	Precautions for Use of LCD Modules	P16-P17
10	Quality Assurance	P18-P23

### For Customer's Acceptance:

Approved By	Comment

PREPARED	CHECKED	VERIFIED BY QA DEPT	VERIFIED BY R&D DEPT
NIKOLA	Cherry Li	Michael Liu	Jacky Liang

**2. Revision Record**

Date	Rev.No.	Page	Revision Items	Prepared
2022-4-28	V0		The first release	NIKOLA

## 3. General Specifications

ZW-T050GGSA-03 is a TFT-LCD module. It is composed of a TFT-LCD panel, driver IC, FPC, a back light and CG unit. The 5.0" display area contains 640 x (RGB)x 480 pixels and can display up to 262K colors. This product accords with ROHS environmental Criterion.

Item	Contents	Unit	Note
LCD Type	TFT	-	
Display color	262K		1
Viewing Direction	ALL	O'Clock	
Operating temperature	-40 ~ +70	°C	
Storage temperature	-40 ~ +85	°C	
Module size	118.65 X 89.43 X 5.87	mm	2
Active Area(W×H)	101.76 X 76.32	mm	
Number of Dots	640 X 480	dots	
Controller	ST5892B	-	
Power Supply Voltage (VDD)	3.3	V	
Backlight	3S6P-LEDs (white)	pcs	
Weight	---	g	
Interface	RGB666	-	
Initialization code version	V2	-	

Note 1: Color tune is slightly changed by temperature and driving voltage.

Note 2: Without FPC and Solder .With CG.

## 4.Outline Drawing

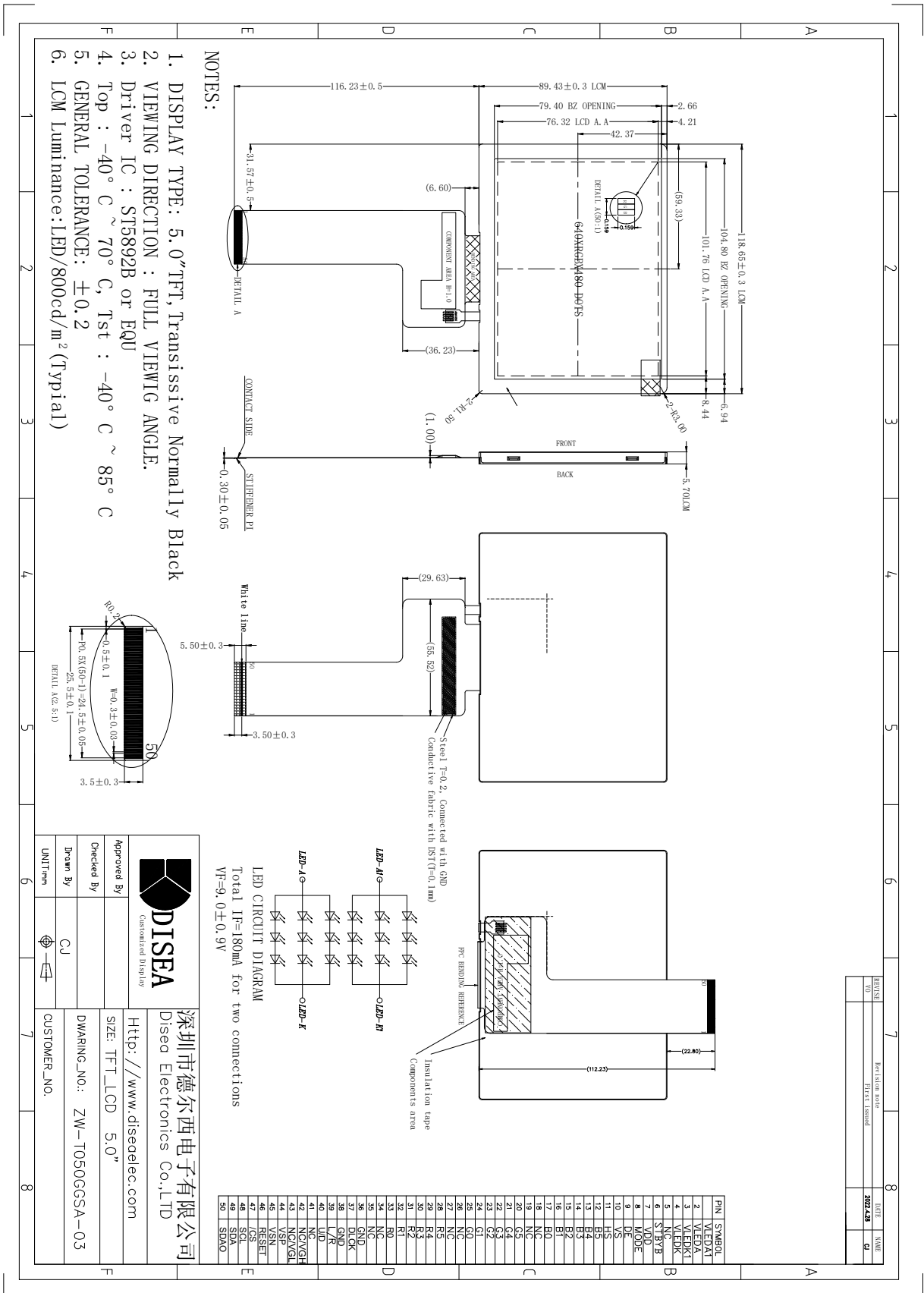

## 5. Absolute Maximum Ratings( $T_a=25\text{ }^\circ\text{C}$ )

### 5.1 Electrical Absolute Maximum Ratings.( $V_{SS}=0V, T_a=25\text{ }^\circ\text{C}$ )

Item	Symbol	Min.	Max.	Unit	Note
Power Supply Voltage	VDD	-0.3	6.0	V	1, 2
	VSP	5.0	7.0	V	1, 2
	VSN	-7.0	-5.0	V	1, 2

**Notes:**

1. If the module is above these absolute maximum ratings. It may become permanently damaged. Using the module within the following electrical characteristic conditions are also exceeded, the module will malfunction and cause poor reliability.
2.  $V_{DD} > V_{SS}$  must be maintained.
3. Please be sure users are grounded when handing LCD Module.

### 5.2 Environmental Absolute Maximum Ratings.

Item	Storage		Operating		Note
	MIN.	MAX.	MIN.	MAX.	
Ambient Temperature	-40 $^\circ\text{C}$	85 $^\circ\text{C}$	-40 $^\circ\text{C}$	70 $^\circ\text{C}$	1,2
Humidity	-	-	-	-	3

**Notes:**

1. The response time will become lower when operated at low temperature.
2. Background color changes slightly depending on ambient temperature.  
The phenomenon is reversible.
3.  $T_a \leq 40\text{ }^\circ\text{C}$ : 85%RH MAX.  
 $T_a > 40\text{ }^\circ\text{C}$ : Absolute humidity must be lower than the humidity of 85%RH at 40 $^\circ\text{C}$ .

## 6. Electrical Specifications

### 6.1 Electrical characteristics (V<sub>SS</sub>=0V, T<sub>a</sub>=25 °C)

Parameter		Symbol	Condition	Min	Typ	Max	Unit
Power supply		VDD	T <sub>a</sub> =25°C	3.0	3.3	3.6	V
		VSP	T <sub>a</sub> =25°C	5.5	6.0	6.5	V
		VSN	T <sub>a</sub> =25°C	-6.5	-6.0	-5.5	V
Input voltage	'H'	V <sub>IH</sub>	T <sub>a</sub> =25°C	0.8*VDD	-	VDD	V
	'L'	V <sub>IL</sub>	T <sub>a</sub> =25°C	0	-	0.2*VDD	V
Power supply current		I <sub>DD</sub>	VDD=3.3V	-	4.8	9.6	mA
		I <sub>SP</sub>	VSP=6.0V	-	4.5	9.0	mA
		I <sub>SN</sub>	VSN=-6.0V	-	3.5	7.0	mA

### 6.2 LED backlight specification (V<sub>SS</sub>=0V, T<sub>a</sub>=25 °C)

Item	Symbol	Condition	Min	Typ	Max	Unit	Note
Supply voltage	V <sub>f</sub>	I <sub>f</sub> =180mA	8.1	9.0	9.9	V	
Uniformity	Δ B <sub>p</sub>	I <sub>f</sub> =180mA	75	80	-	%	
Life Time	time	I <sub>f</sub> =180mA	-	50K	-	hours	1

Note 1: Brightness to be decreased to 50% of the initial value at ambient temperature T<sub>A</sub>=25 °C

## 6.3 Interface signals

Pin No.	Symbol	I/O	Function
1	VLEDA1	P	LED back light(Anode)
2	VLEDA	P	LED back light(Anode)
3	VLEDK1	P	LED back light(Cathode)
4	VLEDK	P	LED back light(Cathode)
5	NC	I	No connect
6	STBYB	I	Standby mode select pin
7	VDD	P	Power supply
8	MODE	I	DE/YSNC mode select. "H" SYNC mode, "L" DE mode.
9	DE	I	Data enable pin
10	VS	I	Frame sync signal
11	HS	I	Line sync signal
12-17	B5~B0	I	Blue data bus
18-19	NC	-	No connection.
20-25	G5~G0	I	Green data bus
26-27	NC	-	No connection.
28-33	R5~R0	I	Red data bus
34-35	NC	-	No connection.
36	GND	P	Ground.
37	DCLK	I	Data clock
38	GND	P	Ground.
39	L/R	I	Right/Left sequence control of source driver. 'H' : S[1]->S[2]->...->S[1920] (Default). 'L' : S[1920]->S[1919]->...->S[1].
40	U/D	I	Gate driver Up/Down scan control of gate driver. 'H' : Scan Up to Down, 'L' : Scan Down to Up.
41	NC	I	No connection.
42	NC/VGH	-	No connection.
43	NC/VGL	-	No connection.
44	VSP	P	Power supply for source driver and power circuit
45	VSN	P	Power supply for source driver and power circuit
46	RESET	I	Reset pin,active "L"
47	/CS	I	SPI pin,No use please NC
48	SCL	I	SPI pin,No use please NC
49	SDA	I	SPI pin,No use please NC
50	SDAO	O	SPI pin,No use please NC



## 6.4 Timing Table

### 6.4.1 SYNC mode.

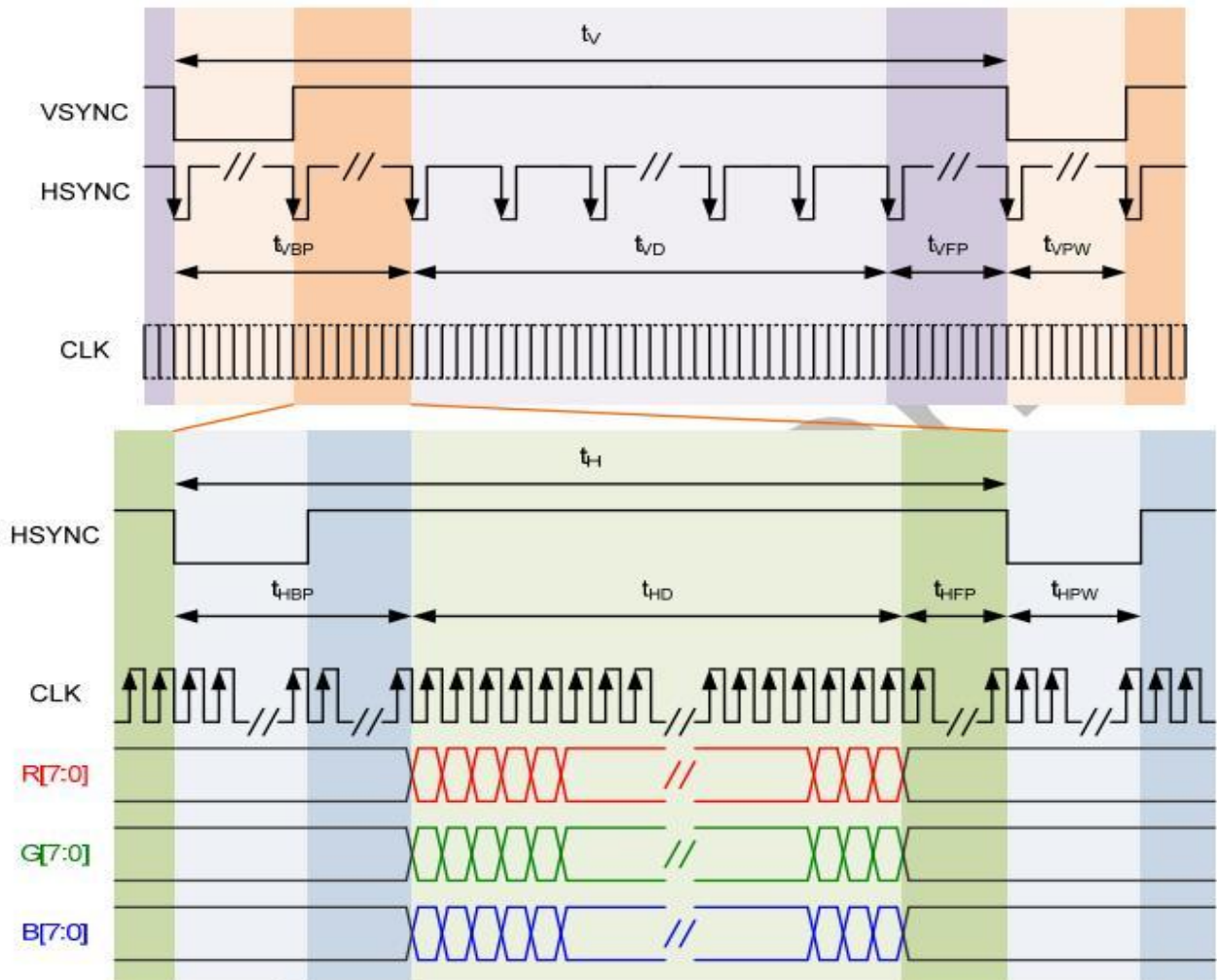

050V6 + ST5892B		Timing Specification			
Parameter	Symbol	Value			Unit
		Min.	Typ.	Max.	
Frame Rate	FR		59.0		Hz
DCLK Frequency	$F_{DCLK}$		21		MHz
Horizontal Address	HACT		640		DCLK
Horizontal Synchronization	Hsync		2		DCLK
Horizontal back porch	HBP		20		DCLK
Horizontal front porch	HFP		20		DCLK
1 horizontal line	Htotal		682		DCLK
Vertical Address	VACT		480		H
Vertical Synchronization	Vsync		2		H
Vertical Back Porch	VBP		20		H
Vertical Front Porch	VFP		20		H
1 vertical field	Vtotal		522		H

Note : 1. Back porch is NOT included pulse width

6.4.2 DE mode.

Parallel RGB

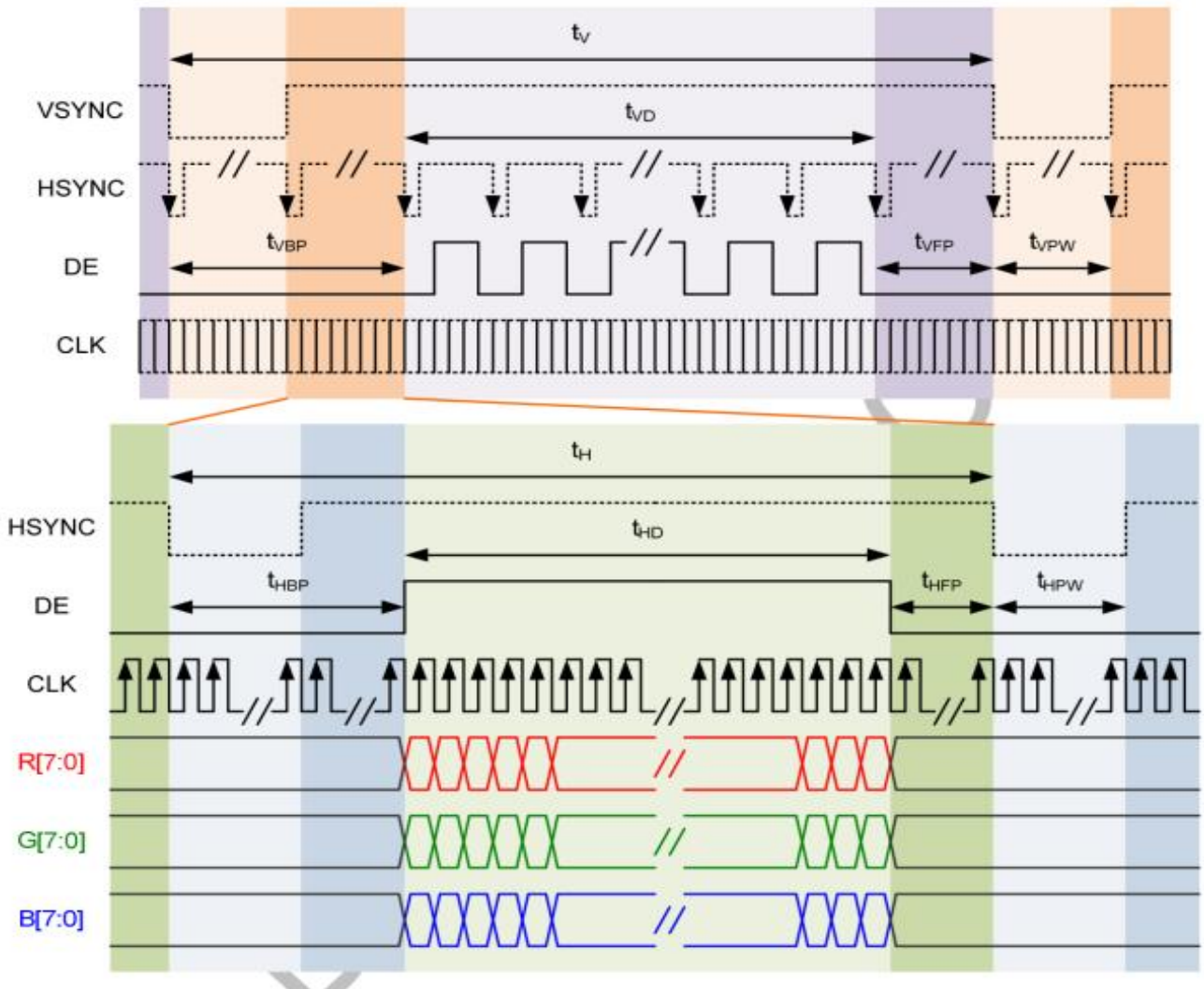

## 6.5 Power On/Off sequence

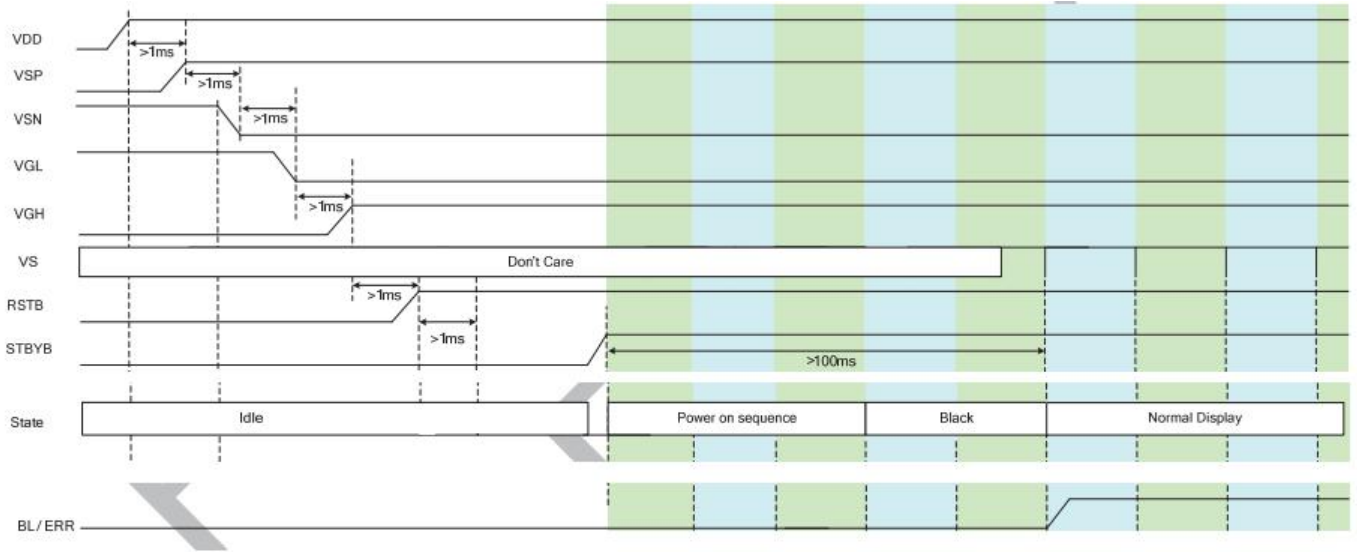

Power On timing chart

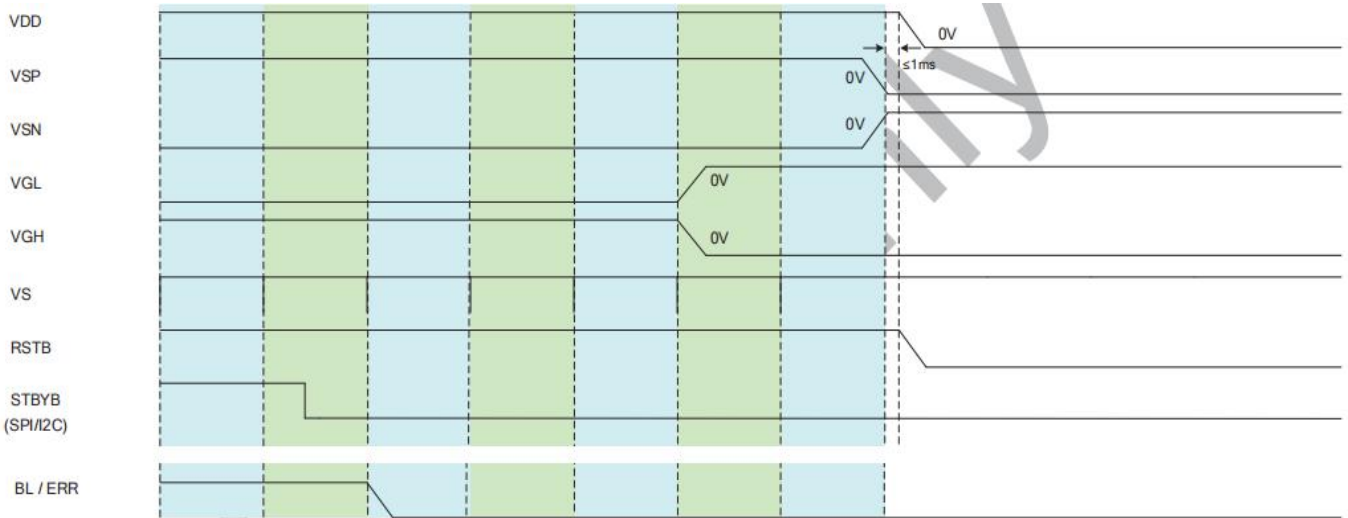

Power Off timing chart

## 7. Optical Characteristics

Item	Symbol	Condition	Min.	Typ.	Max.	Unit	Note	
Brightness	Bp	$\theta=0^\circ$ $\Phi=0^\circ$	750	800	-	Cd/m <sup>2</sup>	1	
Uniformity	$\Delta$ Bp		80	-	-	%	1,2	
Viewing Angle	3:00	Cr $\geq$ 10	-	80	-	Deg	3	
	6:00		-	80	-			
	9:00		-	80	-			
	12:00		-	80	-			
Contrast Ratio	Cr	$\theta=0^\circ$ $\Phi=0^\circ$	800	1000	-	-	4	
Response Time	T <sub>r</sub> +T <sub>f</sub>		-	30	40	ms	5	
Color of CIE Coordinate	W	x	$\theta=0^\circ$ $\Phi=0^\circ$	Typ -0.05	Typ +0.05	-	1,6	
		y				-		
	R	x				0.643		-
		y				0.330		-
	G	x				0.324		-
		y				0.571		-
	B	x				0.138		-
		y				0.134		-
NTSC Ratio	S	-	58	-	%			

Note: The parameter is slightly changed by temperature, driving voltage and materiel

Note 1: The data are measured after LEDs are turned on for 5 minutes. LCM displays full white.

The brightness is the average value of 9 measured spots. Measurement equipment BM-7 (Φ5mm)

Measuring condition:

- Measuring surroundings: Dark room.
- Measuring temperature:  $T_a=25\text{ }^\circ\text{C}$ .
- Adjust operating voltage to get optimum contrast at the center of the display.

Measured value at the center point of LCD panel after more than 5 minutes while backlight turning on.

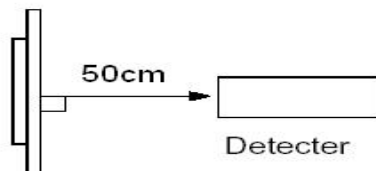

Note 2: The luminance uniformity is calculated by using following formula.

$$\Delta B_p = B_p (\text{Min.}) / B_p (\text{Max.}) \times 100 (\%)$$

$B_p (\text{Max.})$  = Maximum brightness in 9 measured spots

$B_p (\text{Min.})$  = Minimum brightness in 9 measured spots.

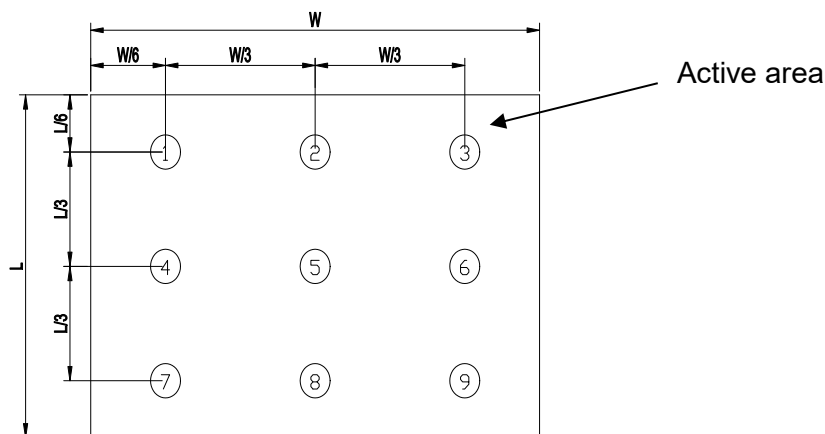

**Note 3: The definition of viewing angle:**  
 Refer to the graph below marked by  $\theta$  and  $\Phi$

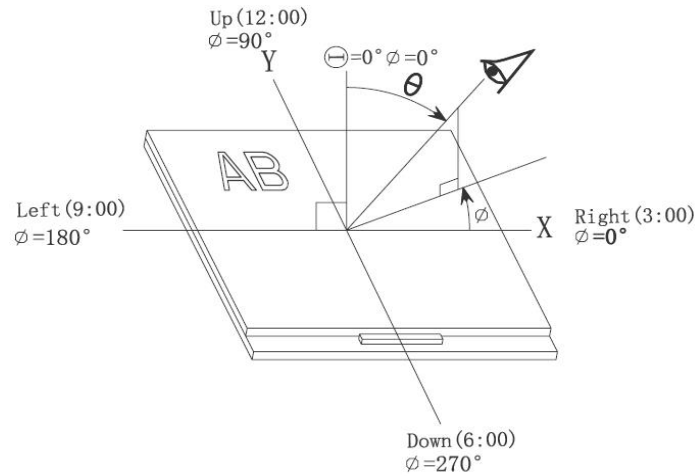

**Note 4: Definition of contrast ratio.( Test LCD using DMS501)**

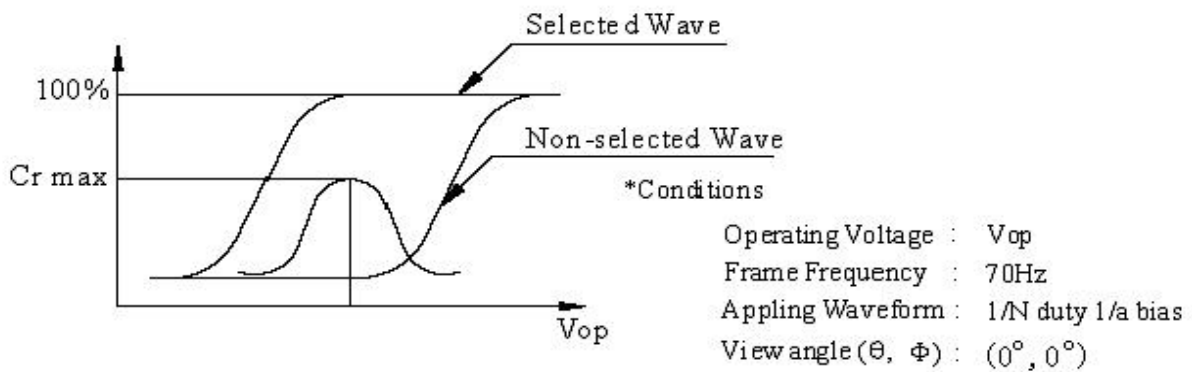

$$\text{Contrast ratio}(Cr) = \frac{\text{Brightness of selected dots}}{\text{Brightness of non-selected dots}}$$

**Note 5: Definition of Response time. (Test LCD using DMS501):**

The output signals of photo detector are measured when the input signals are changed from “black” to “white”(falling time) and from “white” to “black”(rising time), respectively. The response time is defined as the time interval between the 10% and 90% of amplitudes. Refer to figure as below.

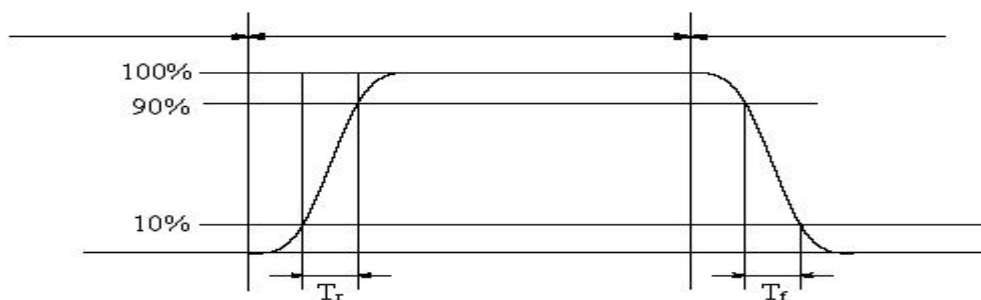

The definition of response time

Note 6: Definition of Color of CIE Coordinate and NTSC Ratio.

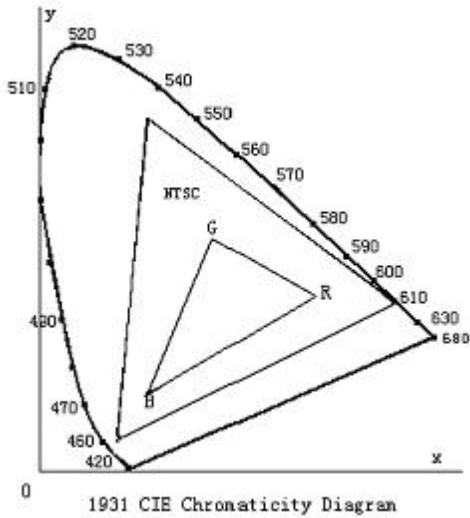

Color gamut:

$$S = \frac{\text{area of RGB triangle}}{\text{area of NTSC triangle}} \times 100\%$$

Note 7: Definition of cross talk.

Cross talk ratio(%) =  $\frac{|\text{pattern A Brightness} - \text{pattern B Brightness}|}{\text{pattern A Brightness}} \times 100$

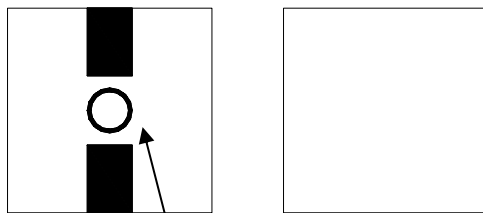

Pattern A

Pattern B

Measurement point(center)

Electric volume value =  $3F \pm 3Hex$



## 8. Reliability Test Items and Criteria

Test Item	Test condition	Remark
High Temperature Storage	Ta = 85°C 240hrs	Note1,Note3, 4
Low Temperature Storage	Ta = -40°C 240hrs	Note1,Note3, 4
High Temperature Operation	Ta = 70°C 240hrs	Note2,Note3, 4
Low Temperature Operation	Ta = -40°C 240hrs	Note1,Note3, 4
Operation at High Temperature/Humidity	+60°C, 90%RH 240hrs	Note3, 4
Thermal Shock	-40°C/30 min ~ +85°C/30 min for a total 10 cycles, Start with cold temperature and end with high temperature.	Note3, 4
Vibration Test	Frequency range:10~55Hz Stroke:1.5mm Sweep:10Hz~55Hz~10Hz 2 hours for each direction of X. Y. Z. (6 hours for total)	
Mechanical Shock	100G 6ms,±X, ±Y, ±Z 3 times for each direction	
Package Vibration Test	Random Vibration : 0.015G*G/Hz from 5-200HZ, -6dB/Octave from 200-500HZ 2 hours for each direction of X. Y. Z. (6 hours for total)	
Package Drop Test	Height:60cm 1 corner, 3 edges, 6 surfaces	
Electro Static Discharge	±2KV, Human Body Mode, 100pF/1500Ω	

Note 1: Ta is the ambient temperature of samples.

Note 2: Ts is the temperature of panel's surface.

Note 3: In the standard condition, there shall be no practical problem that may affect the display function. After the reliability test, the product only guarantees operation, but don't guarantee all of the cosmetic specification.

Note 4: Before cosmetic and function test, the product must have enough recovery time,at least 2 hours at room temperature



## **9. Precautions for Use of LCD Modules**

### **9.1 Handling Precautions**

9.1.1 *The display panel is made of glass. Do not subject it to a mechanical shock by dropping it from a high place, etc.*

9.1.2 *If the display panel is damaged and the liquid crystal substance inside it leaks out, be sure not to get any in your mouth, if the substance comes into contact with your skin or clothes, promptly wash it off using soap and water.*

9.1.3 *Do not apply excessive force to the display surface or the adjoining areas since this may cause the color tone to vary.*

9.1.4 *The polarizer covering the display surface of the LCD module is soft and easily scratched. Handle this polarizer carefully.*

9.1.5 *If the display surface is contaminated, breathe on the surface and gently wipe it with a soft dry cloth. If still not completely clear, moisten cloth with one of the following solvents:*

— Isopropyl alcohol      — Ethyl alcohol

*Solvents other than those mentioned above may damage the polarizer. Especially, do not use the following:*

— Water                      — Ketone                      — Aromatic solvents

9.1.6 *Do not attempt to disassemble the LCD Module.*

9.1.7 *If the logic circuit power is off, do not apply the input signals.*

9.1.8 *To prevent destruction of the elements by static electricity, be careful to maintain an optimum work environment.*

*a. Be sure to ground the body when handling the LCD Modules.*

*b. Tools required for assembly, such as soldering irons, must be properly ground.*

*c. To reduce the amount of static electricity generated, do not conduct assembly and other work under dry conditions.*

*d. The LCD Module is coated with a film to protect the display surface. Be care when peeling off this protective film since static electricity may be generated.*

## **9.2 Storage precautions**

9.2.1 *When storing the LCD modules, avoid exposure to direct sunlight or to the light of fluorescent lamps.*

9.2.2 *The LCD modules should be stored under the storage temperature range. If the LCD modules will be stored for a long time, the recommend condition is:*

*Temperature :           0 °C ~ 40 °C*

*Relatively humidity: ≤ 80%*

9.2.3 *The LCD modules should be stored in the room without acid, alkali and harmful gas.*

**9.3 *The LCD modules should be no falling and violent shocking during transportation, and also should avoid excessive press, water, damp and sunshine.***

## **10 . Quality Assurance**

### **10.1.Objective**

The TFT criteria is set to formalize the TFT quality standards with reference to customer for inspection.

### **10.2.Scope**

The criteria is applicable to this TFT products manufactured by DISEA.

### **10.3.Tools for Inspection**

Tester, calipers, multi-meter, anti-static wrist straps, finger cots, desk Lamps, etc.

### **10.4.Sampling Plan and Reference Standards**

#### 10.4.1.1 Sampling plan:

Refer to GB/T2828.1-2012/ISO2859-1:1999 //MIL-STD-105E

AQL: level II; normal:

1) MA=0.40

2) MI=0.65

#### 10.4.1.2 IPC-A-610 Acceptability of Electronic Assemblies.

### **10.5.Inspection Conditions and Inspection Reference**

#### **10.5.1** Cosmetic inspection with naked eyes:

1) Temperature:  $23\pm 5^{\circ}\text{C}$ ; relative humidity:45~75%RH

2) Illumination: 500lux~1000lux

3) Distance:  $30\text{cm}\pm 5$  from the inspector's naked eyes to the LCD panel.

4) View angle: within  $45^{\circ}$  from perpendicular to LCM surface (view direction and special parameters refer to production specification).

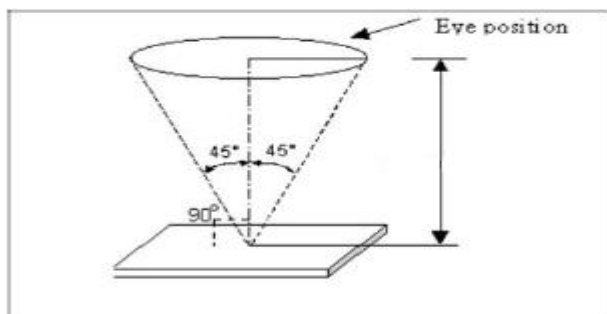

## 10.5.2 Definition

### 10.5.2.1 Area definition

A area: Active area (AA area)

B area: Viewing area (VA area)

C area: non-view area (out of B area)

10.5.2.2 Any cosmetic defect which do not affect product quality and customer assembling in C area, it's Acceptable. (The dimension is defined on the drawings)

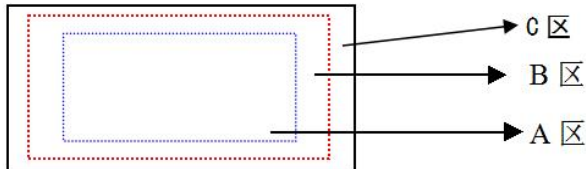

10.5.2.3 Test condition: refer to product specification

## 10.5.3 Defect type:

### 10.5.3.1 A area defect type:

Line defect (scratch, soft flocks, fibre)、dot defect (white dot, black dot, same color dot, different color dot, bubble)、stain, pin-hole, light leak, scratch.

### 10.5.3.2 B area defect type:

Broken, crack/chipping, FPC defect

10.5.4 Undefined items or other special items, refer to mutual agreement and limited sample by customer.

10.5.5 Test condition: refer to product specification.

## 10.6. Defects and Acceptance Standards

### 10.6.1 Appearance inspection

#### 10.6.1.1 Dot/line defect

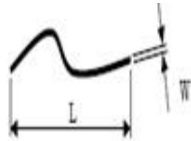
Defect	5"	Accepted standard	MAJ	MIN
<b>S/C , line defect</b> <b>W:width</b> <b>L:length</b> 	$W \leq 0.05\text{mm}$	Accept		√
	$0.05\text{mm} < W \leq 0.10\text{mm}$ , $L \leq 5\text{mm}$ quantity $\leq 2$ distance $> 10\text{mm}$	Accept		√
	$W > 0.10\text{mm}$ $L > 5\text{mm}$	Reject		√
<b>Dot defect</b> <b>(black/white spot, foreign objects etc)</b>	$D \leq 0.2\text{mm}$	Accept		√
	$0.2\text{mm} < D \leq 0.5\text{mm}$ quantity $\leq 2$ distance $> 10\text{mm}$	Accept		√

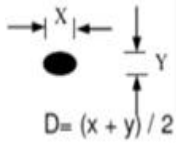
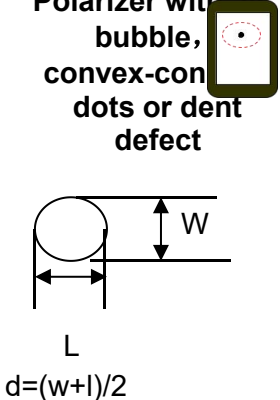
<b>D:Diameter</b>  $D = (x + y) / 2$	$D > 0.5\text{mm}$	Reject		√
<b>Polarizer with air bubble, convex-concave dots or dent defect</b>  $d = (w + l) / 2$	$D \leq 0.20\text{mm}$	Accept		√
	$0.20\text{mm} < D \leq 0.5\text{mm}$ quantity $\leq 2$	Accept		√
	$d > 0.5\text{mm}$	Reject		√

### 10.6.1.2 Chip and Crack

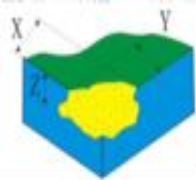
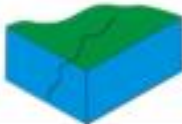

Defect	5"	Accepted standard	MAJ	MIN
<b>Chip</b> 	$X \leq 0.3\text{mm}, Y \leq 0.3\text{mm},$ one side $\leq 1$	Accept		√
	$X > 0.3\text{mm},$ $Y > 0.3\text{mm}$	Reject		√
<b>Sensor chip</b>	Not affect ITO line, not lengthen, function test is OK. And be non-visual after attaching Lens.	Accept		√
	Affect ITO line and be visual.	Reject		√
<b>Glass crack</b> 	Glass crack.	Reject		√

### 10.6.1.3 Attaching defect (kapton tape/protective film)

Defect	Description	Accepted standard	MAJ	MIN
<b>High temperature kapton tape</b>	Kapton tape attached on FPC doesn't meet the criterion of drawing.	Reject		√
<b>Protective film</b>	Clean、 attaching flat、 no shifting	Accept		√

## 10.6.2 TFT defects and Inspection Criterion

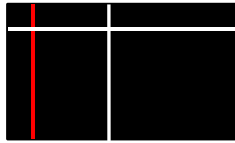
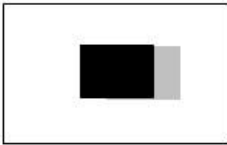
### 10.6.2.1 Function items

Defects	Inspection Criterion	Pictures	Inspection method/tools	Defect category
No display /function	shows no picture/display in normal connected situation. ->Rejected		Naked eyes/ testers	MA
Missing segment	Shows missing lines in normal display.->Rejected		Naked eyes/ testers	MA
Image retention (sticking)	The previous picture stays in the next picture. Disappear time <10s, OK; time>10s, NG		Naked eyes/ testers	MA
Flicker	Not accepted	/	Naked eyes/ testers	MA
Display abnormal	Not accepted		Naked eyes/ testers	MA
Display dim/bright	Refer to bright value definition	/	Naked eyes/ BM-7	MA
Contrast	Refer to SPEC	/	Naked eyes/ BM-7	MA
Circular White Mura, Lumination Mura, Black/White Mura, etc	Judged by 5%ND Filter in 50% gray pattern.	/	Naked eyes/ testers	MI

## 10.6.2.2 LCD pixel defect(defect category: MI)

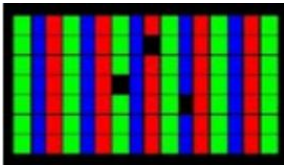
Defects	Inspection Criterion	Pictures	Inspection method/tools	Acceptable Quantity
LCD pixel defect	Bright pixel display		Naked eyes/ Testers	0
	Black pixel display		Naked eyes/ testers	0

### 10.6.4 B/L defect

Item	Description	Judgment	Defect
B/L scratch wound	---	Dot/line defect judgement	minor
Black display	Black light while power on	NG	major
B/L particle /white black dot	impurities, foreign body, fiber, top injury	Dot line defect judgement	minor
leaking	Vision area leaking	NG or by Sample	minor
	Leaking between LCD and Backlight	Can not exceed 1/2 single line	minor
Display irregular	Colour difference with Samples	NG	major
	Lighter or darker	NG or By sample	minor
Water/white print at Backlight	Water/ white print occurred when Lighting	NG	minor
Interference ripple	Interference ripple occurred when Lighting	NG	minor
B/L faulty	Not smooth,uneven light	NG or By sample	minor

## **10.7.Others**

10.7.1 Some defect items are not defined in this document, obey to final negotiation between customer and manufacturer or sign limit sample.

10.7.2 If final goods includes FPC/PCB, inspection criterion refers to IPC-610, Level 2

**END**