

# Datasheet

## FORTEC Integrated

### PrismaMINI-HDMI-DP-II

TFT controller based on MStar graphic for connecting MINI TFT displays to HDMI/ DP

PR-01-431 | PR-01-431\_A1 | PR-01-431\_A2



Version 1.4

06.12.2023

**FORTEC**  
UNITED STATES



**FORTEC**  
INTEGRATED



**FORTEC**  
UNITED KINGDOM



---

The information contained in this document has been carefully researched and is, to the best of our knowledge, accurate. However, we assume no liability for any product failures or damages, immediate or consequential, resulting from the use of the information provided herein. Our products are not intended for use in systems in which failures of product could result in personal injury. All trademarks mentioned herein are property of their respective owners. All specifications are subject to change without notice.

---

## Table of Contents

1	Revision History .....	5
2	Overview .....	6
3	General Features .....	6
3.1	Hardware Features .....	7
4	Power Concept.....	8
5	OSD Menu and User Controls.....	9
5.1	OSD Control through external Keypad.....	9
5.1.1	4-Button OSD Keypad ZU-02-398 .....	9
6	On-Screen-Menu .....	10
6.1	Brightness/Contrast Tab .....	10
6.2	Color Settings Tab .....	10
6.3	Input Source Tab .....	11
6.4	Display Settings Tab .....	11
6.5	Other Settings Tab .....	12
6.6	Information Tab .....	12
6.7	External Devices Tab.....	13
6.7.1	Submenu "Ambient Light Sensor": .....	13
6.7.2	Submenu "Temperature Sensor":.....	14
6.7.3	Submenu "Controllers":.....	14
6.8	Input Source Window .....	15
6.9	Brightness Control .....	15
7	Supported Input Modes .....	16
7.1	HDMI – Graphics .....	16
7.2	HDMI – Video .....	16
7.3	DisplayPort .....	16
8	Absolute Maximum Ratings .....	18
9	Electrical Characteristics .....	18

---

9.1	Maximal allowed power consumption for TFT Panels ( $I_{SVCC}$ ) .....	18
9.2	Maximal allowed power consumption for backlight converter ( $I_{SV\_BKLT}$ ) .....	18
9.3	Recommended power supply wiring .....	19
10	Mechanical Specification .....	20
10.1	Dimensions .....	20
10.2	Drawing.....	20
11	Connector Overview .....	21
11.1	Input Connectors.....	22
11.2	Output Connectors.....	24
11.3	I/O Connector .....	25
12	Accessories.....	26
12.1	Light Sensor ZU-02-412 .....	26
12.2	Temperature Sensor ZU-02-389 .....	26
12.3	Frozen Screen Detector ZU-02-512 .....	26
13	Programming, configuration and ROSD via serial port .....	27
13.1	HW requirements .....	27
13.2	ROSD Protocol .....	28

## 1 Revision History

Date	Rev.No.	Description	Page
03.12.2021	1.0	Initial version	All
23.12.2022	1.1	Removed chapter 5.1.2	10
		Mechanical dimensions: added Picture/ changed structure	19
		Added Note: OSM restrictions	10
06.02.2023	1.2	Completed mechanical dimensions	19
20.10.2023	1.3	Added _A1, _A2; Added "75R Serial resistor"	2,23
06.12.2023	1.4	Added chapter 9.3 "Recommended power supply wiring"	19
		Changed to new template	All
		More specified naming, removed duplicated items (Current)	18

## 2 Overview

PrismaMINI-HDMI-DP-II is a TFT-Controller board based on the TSUMOP88CDT9-1 (MStar) graphic-chip. It is a cost-efficient solution designed for cost sensitive applications up to 1920x1200 and no need for different inputs or other additional functionalities. PrismaMINI-HDMI-DP-II is focused on the essential: one panel – two input types.

## 3 General Features

- 3.3V - 12V panel power input
- 3.3V – 12V backlight power input
- DP1.2a, HDMI 1.3 (compatible with HDMI 1.4)
- Supports 18 and 24-bit color depth.
- Supports VESA DDC/CI and Full Green Mode VESA DPMS support
- Support OSD Rotation 0, 90, 180, 270 degrees
- DDC-Control on HDMI and Display Port
- Remote control capability (Remote OSD via PC)
- PWM-controlled backlight intensity
- Four and Six-button external OSD-keypad interface and on-screen menus allow adjustments to the system.
- Auto Brightness regulation in combination with an ambient light sensor (optional accessory available)
- Supports temperature sensor (optional accessory available)
- Supports "Frozen-Screen Detection System" (optional accessory available)
- Fully Customizable through the configuration software (MstarRover)
- RoHS



### 3.1 Hardware Features

#### Ultra-Reliable HDMI 1.3 Receiver

- Single Link TMDS Rx for up to 12-bit 1080p
- Captures up to 225MHz.
- Direct connect to all HDMI compliant TMDS transmitters

#### DisplayPort Receiver

- 10.8Gbps total bandwidth over 4 lanes

#### LVDS-Interface

- Supports up to 8-bit LVDS WUXGA (1920x1200) panel interface.
- Spread Spectrum output frequency for EMI suppression.

#### On Screen Display

- Supports OSD rotation degree 0°, 90°, 180°, 270°
- Support 2/4/8/16 multi color font

#### Output Format

- Single/double wide LVDS up to WUXGA 60Hz output
- Support for 8 or 6-bit panels (with high-quality dithering)

#### 4 Power Concept

Panel Power Supply (VCC)

+3.3VDC  
to  
+12VDC



Panel Power (SVCC)

+3.3VDC  
to  
+12VDC



Backlight Power Supply (V\_BKLT):

+3.3VDC  
to  
+12VDC



Backlight Power Supply (SV\_BKLT):

+3.3VDC  
to  
+12VDC



Logic Power Supply

+3.3VDC



DC-DC Converter  
+1.2V

3.3V

1.2V

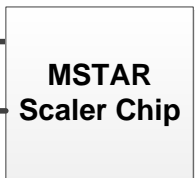

MSTAR  
Scaler Chip

## 5 OSD Menu and User Controls

The OSD allows selection of input source and fine tuning of various functional parameters like brightness, contrast etc. These parameters can be adjusted via an external interface.

### 5.1 OSD Control through external Keypad

An OSD-Keypad can be used to control the OSD. There is a 4-Button and 6-Button OSD Keypad available. It depends on the factory settings of the firmware, which keypad is active. The 4/6-Button Keypad can be selected in the submenu: OSD Settings -> Keypad Layout.

Cable to be used with Keypads: **KA-30-613** (connect to CON8)

#### 5.1.1 4-Button OSD Keypad ZU-02-398

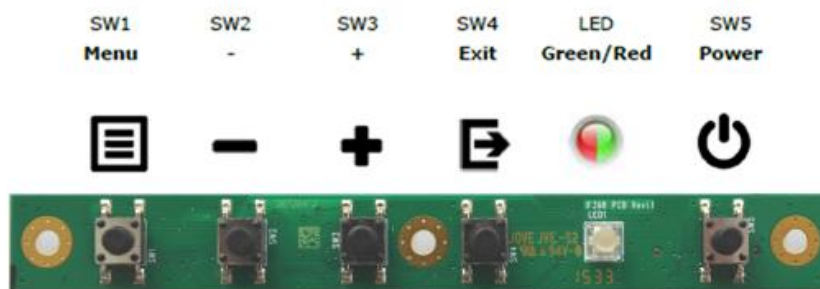

The following tables give you an overview about the functionality.

	Menu	-	+	Exit	LED	Power
General					See below	Power ON/OFF
OSD closed	Open OSD	*	Brightness	Input Select		
OSD open	Select	Down/Left/-	Up/Right/+	Exit/Back		

#### LED-Status:

- Green : Signal Found
- Green flashing : Searching Signal.
- Red : Power Safe
- LED OFF : Power OFF
- Red flashing : No Panel Configuration is flashed.



## 6 On-Screen-Menu

*Please note: For technical reasons OSD menu is only available when horizontal output resolution(active) exceeds 696 pixels.*

### 6.1 Brightness/Contrast Tab



**Brightness:** Brightness of the image can be controlled using this function, with left and right buttons after the brightness slider is selected. This function modifies RGB data or Backlight brightness (depending on configuration) to change the brightness.

**Contrast:** Allows <Contrast> adjustment in the Y domain. The modification affects all color channels and all input types and is a direct multiplication of the Y data after YUV black level adjustment.

### 6.2 Color Settings Tab



**Color Temp:** Allows selection of different color temperature schemes, predefined and custom. Available if the color space of the input is RGB.

**Red, Green, Blue:** Control the amount of the corresponding color components in the displayed image.

**Hue:** Allows <Hue> adjustment in the UV domain. The modification affects all color channels and all input types. Available if the color space of an input is not RGB.

**Saturation:** Allows <Saturation> adjustment in the UV domain. The modification affects all color channels and all input types. Available if the color space of an input is not RGB.

**Color Format:** Switches between RGB and YUV color spaces.

## 6.3 Input Source Tab

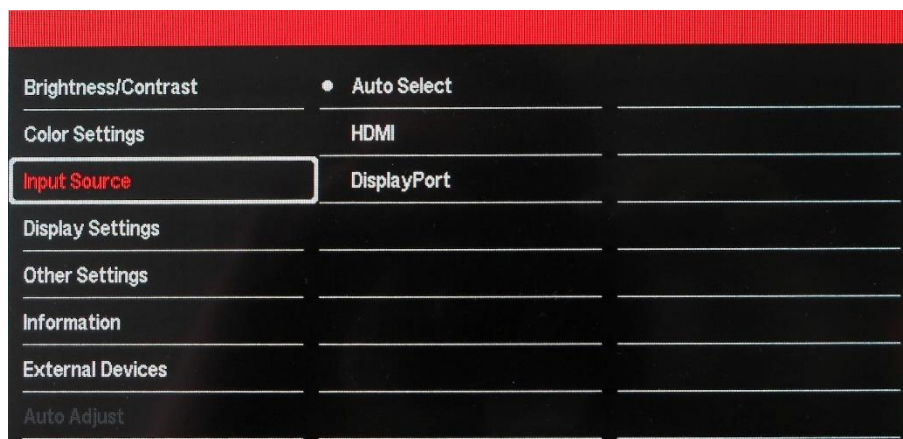

Enables the manual selection of the input source, **Auto Select** enables / disables input auto-detection

## 6.4 Display Settings Tab

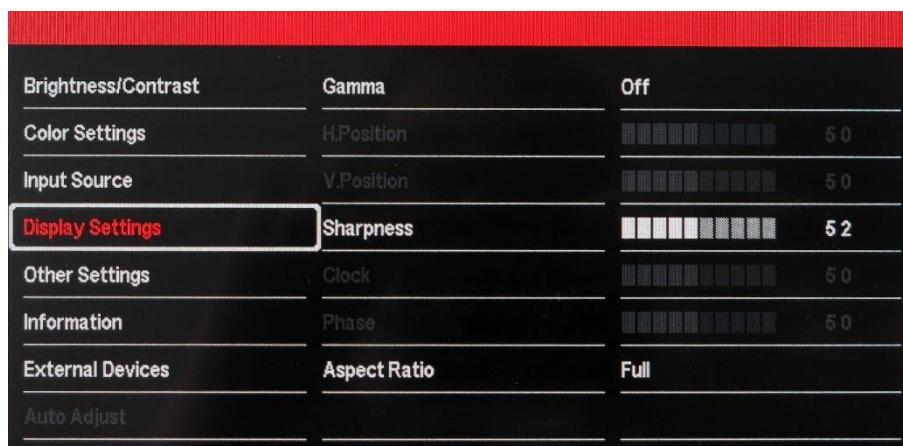

**Gamma:** Enables or disables the gamma correction.

**Sharpness:** Allows <Sharpness> adjustment of the image.

**Aspect Ratio:** Allows adjustment of the display's width to height proportions.

## 6.5 Other Settings Tab

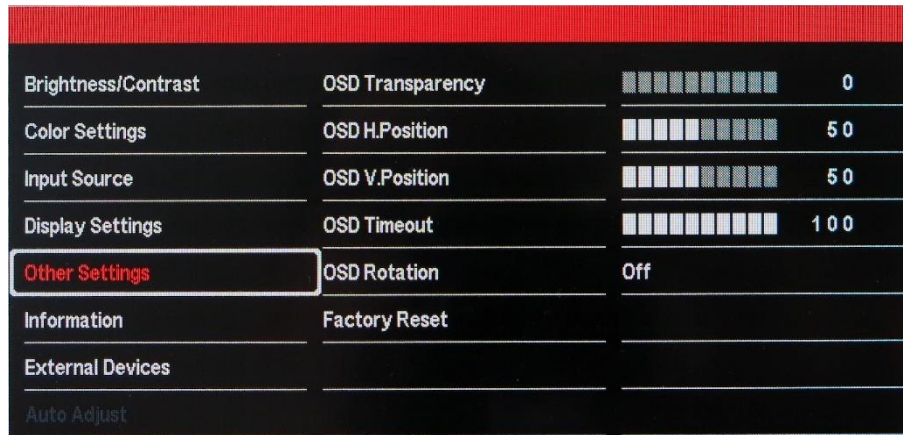

**OSD Transparency:** Sets the transparency level of the OSD Menu on the 0 to 5 scale (0 – not transparent, 5 – barely visible)

**OSD H.Position:** Sets the horizontal OSD Menu position on the screen (in percent of the horizontal screen resolution)

**OSD V.Position:** Sets the vertical OSD Menu position on the screen (in percent of the vertical screen resolution)

**OSD Timeout:** Selects how many seconds the OSD will remain active after the last action has been performed.

**OSD Rotation:** Rotates the OSD Menu by 90, 180 or 270 degrees.

**Factory Reset:** Resets the display settings to the default ones.

## 6.6 Information Tab

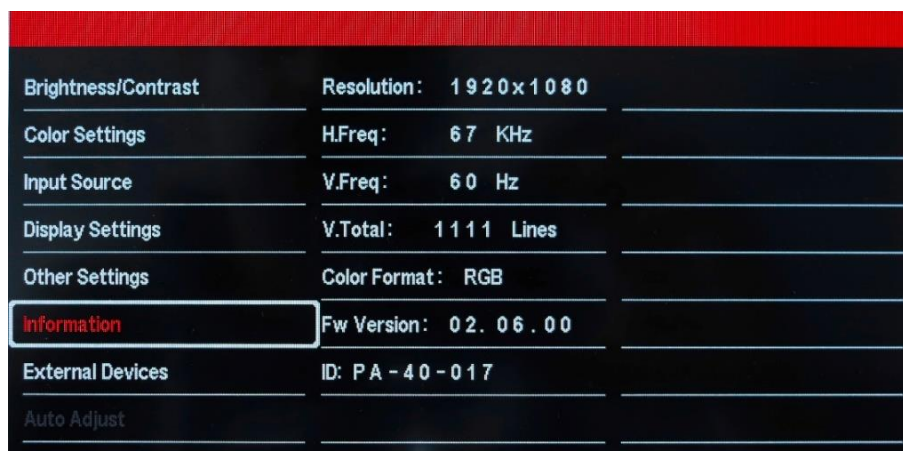

Shows Input Resolution and FW revision and ID information.

## 6.7 External Devices Tab

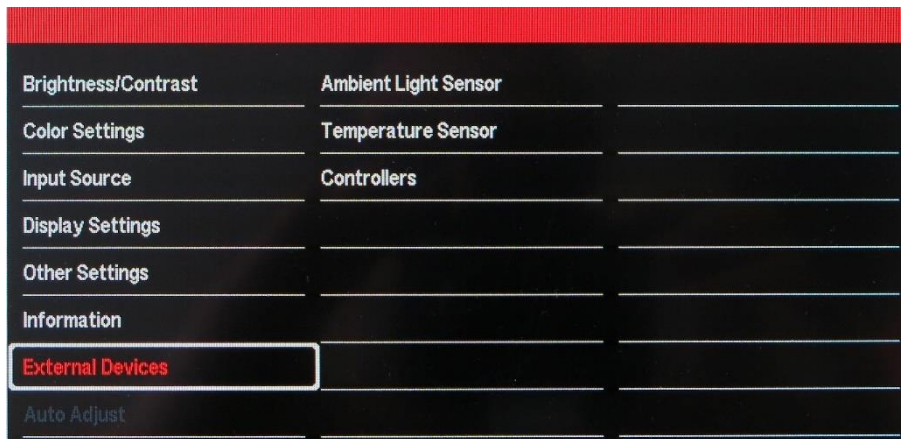

### 6.7.1 Submenu "Ambient Light Sensor":



**Auto Brightness ON/Off:** activates auto brightness function (available when optional [light sensor](#) is connected).

**Br. Adjustment Interval[s]:** sets the time of Brightness adjustment interval.

For more information and activation of detailed settings refer to

*"Manual\_For\_ALS\_And\_Temperature\_Sensor\_Integration"* or contact FORTEC Integrated customer service.



6.7.2 Submenu "Temperature Sensor":



**Temp. Ctrl ON/Off:** activates temperature control (available when optional [temperature sensor](#) is connected)

**Current Temp [°C]:** displays current temperature.

For more information and activation of detailed settings refer to

"Manual\_For\_ALS\_And\_Temperature\_Sensor\_Integration" or contact FORTEC Integrated customer service.

6.7.3 Submenu "Controllers":

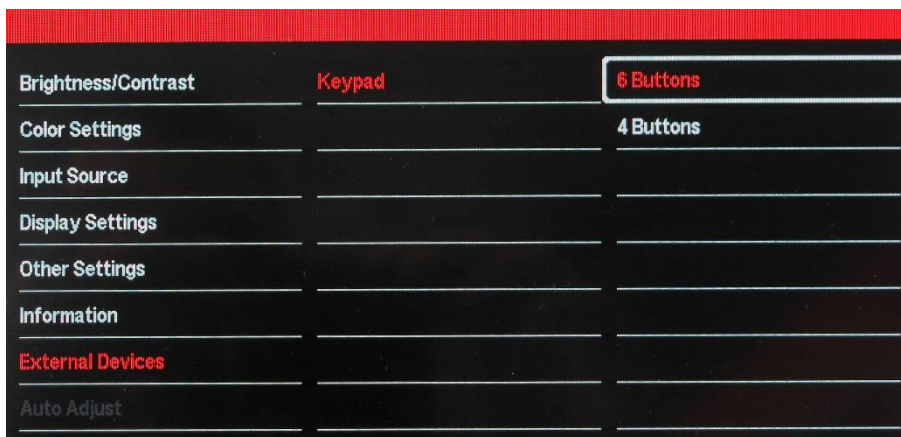

**Keypad:** switches between [4 Buttons](#) and 6 Buttons keypad.

## 6.8 Input Source Window

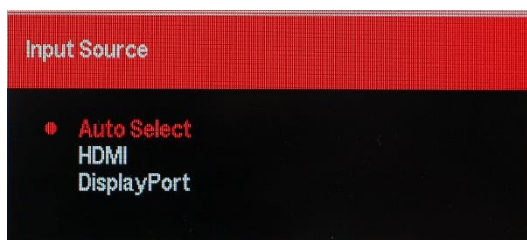

Select the input signal source without going into the main menu.

## 6.9 Brightness Control

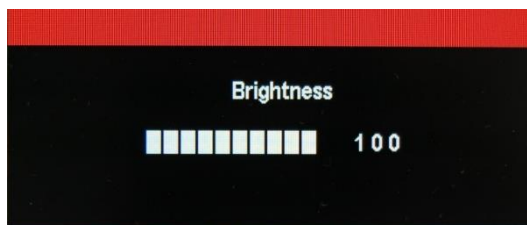

Controls the brightness of the display.

## 7 Supported Input Modes

The PrismaMINI-HDMI-DP-II can support the following input modes.

### 7.1 HDMI – Graphics

The PrismaMINI-HDMI-DP-II is equipped with the HDMI connector, CON11. The factory pre-set supported input modes include:

Resolution	Resolution
640 x 480 @ 60 Hz (VESA)	1360 x 768 @ 60 Hz
800 x 600 @ 60 Hz (VESA)	1366 x 768 @ 60 Hz
1024 x 768 @ 60 Hz (VESA)	1368 x 768 @ 60 Hz
1280 x 768 @ 60 Hz	1600 x 1200 @ 60 Hz (VESA)
1280 x 800 @ 60 Hz	1920 x 1200 @ 60 Hz
1280 x 1024 @ 60 Hz (VESA)	1920 x 1080 @ 60 Hz

### 7.2 HDMI – Video

The factory pre-set supported input modes include:

Resolution	Resolution
720 x 480 @ 60	1280 x 720 @ 60
720 x 576 @ 50	1920 x 1080 @ 50
1280 x 720 @ 50	1920 x 1080 @ 60

### 7.3 DisplayPort

The PrismaMINI-HDMI-DP-II is equipped with one DP connector, CON2. The factory pre-set supported input modes include:

Resolution	Resolution
640 x 480 @ 60 Hz (VESA)	1360 x 768 @ 60 Hz
800 x 600 @ 60 Hz (VESA)	1366 x 768 @ 60 Hz
1024 x 768 @ 60 Hz (VESA)	1368 x 768 @ 60 Hz
1280 x 768 @ 60 Hz	1600 x 1200 @ 60 Hz (VESA)
1280 x 800 @ 60 Hz	1920 x 1200 @ 60 Hz
1280 x 1024 @ 60 Hz (VESA)	1920 x 1080 @ 60 Hz

Note that PrismaMINI-HDMI-DP-II is performing Source Detection according to DisplayPort 1.1a specification. If your source is not detected by PrismaMINI-HDMI-DP-II, please check if the pull-up and pull-down requirements for the AUX-channel are fulfilled:

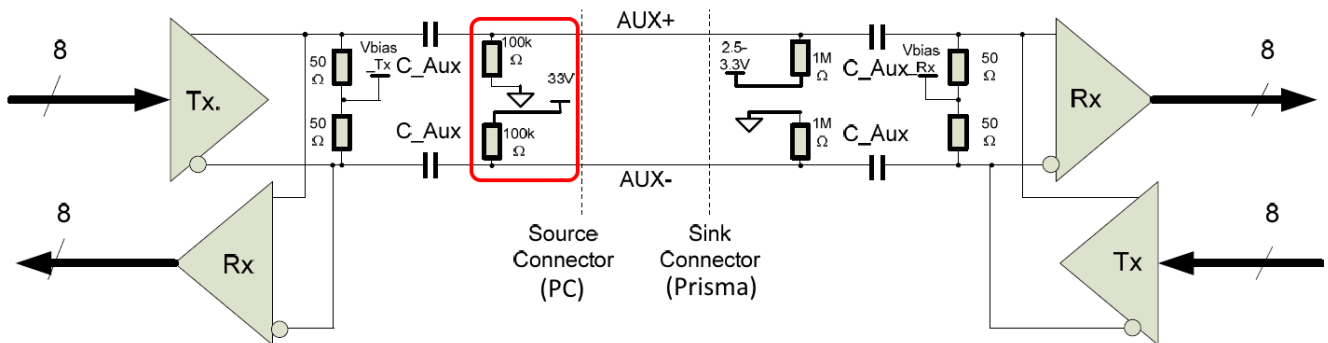

*The DisplayPort Source Device must weakly pull down the AUX+ line and weakly pull up the AUX- line with 100kΩ (+/- 5%) resistors between the AC-coupling capacitor and the Source Connector to assist detection of DisplayPort Source and Powered DisplayPort Source by the Sink Device.*

*(VESA DisplayPort Standard, Version 1, Revision 1a, January 11, 2008, chapter 3.4)*



## 8 Absolute Maximum Ratings

Item	Symbol	Min.	Max.	Unit	Note
Supply Voltage Backlight	V_BKLT	0	14	VDC	1, 2,3
Supply Voltage Panel	VCC	0	14	VDC	1, 2,3
Supply Voltage	+3.3V_Input	0	3.6	VDC	1, 2,3
Storage Temperature	T <sub>st</sub>	-35	+85	°C	
Operating Temperature	T <sub>op</sub>	-20	+70	°C	

**Note (1):** Within operating temperature range.

**Note (2):** Supply voltage limits are for the PrismaMINI-HDMI-DP-II. The backlight of the panel is to be powered through the PrismaMINI-HDMI-DP-II board.

**Note (3):** Permanent damage to the device may occur if maximum values are exceeded.

## 9 Electrical Characteristics

All measurements done at 25°C ambient temperature.

Item	Condition	MIN.	TYP.	MAX.	Unit	Note
Supply Voltage		3.2	3.3	3.6	VDC	
Current Consumption (3.3V)	Power-OFF	0	60	80	mA	
	Sleep mode	0	60	80	mA	
	Board only DP Input Full HD	0	211	300	mA	

### 9.1 Maximal allowed power consumption for TFT Panels (I<sub>SVCC</sub>)

Item	Symbol	Max.	Unit	Note
3.3V, (5V), [12V] (SVCC) Panel power	I <sub>SVCC</sub>	2.0	A	

### 9.2 Maximal allowed power consumption for backlight converter (I<sub>SV\_BKLT</sub>)

Item	Symbol	Max.	Unit	Note
3.3V, (5V), [12V] (SV_BKLT) Backlight power on CON4	I <sub>SV_BKLT</sub>	2.0	A	

## 9.3 Recommended power supply wiring

To avoid voltage drops on the supporting power wires, it is strongly recommended to use separate powerlines for each power input (especially when high current backlight controllers are used).

The connection between the 3 ground lines should be as close as possible to the power input (CON 3).

Recommended wiring (example):

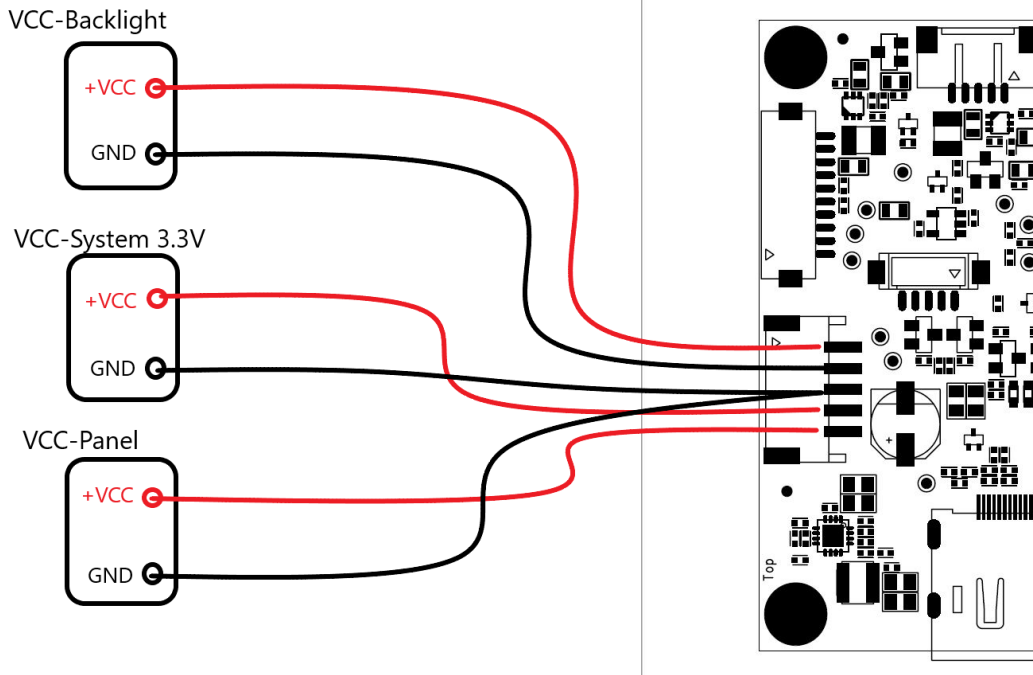

Not recommended wiring (example):

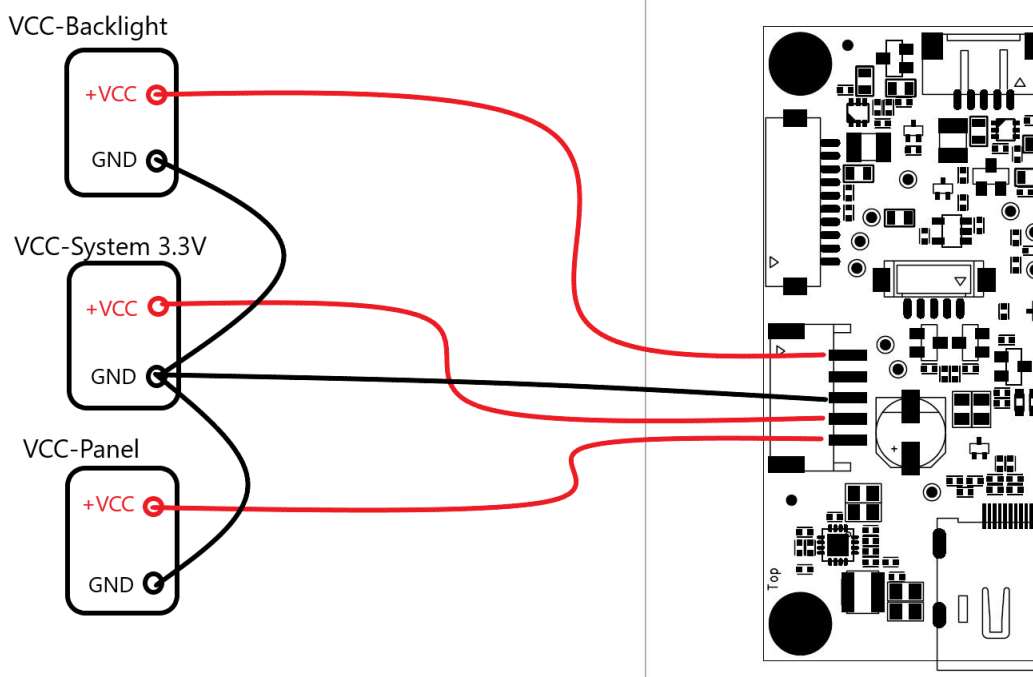

## 10 Mechanical Specification

### 10.1 Dimensions

Item	Value	Tolerance	Note
Length (PCB)	75mm	± 0.5 mm	
Width (PCB)	60mm	± 0.5 mm	
Height (top side)	8.5mm	+ 0.3 mm	1
Height (bottom side)	0.5mm	-0.5mm	
PCB Thickness	1.6mm	± 0.1 mm	
Weight	26g	± 1g	

Note (1): including PCB thickness.

### 10.2 Drawing

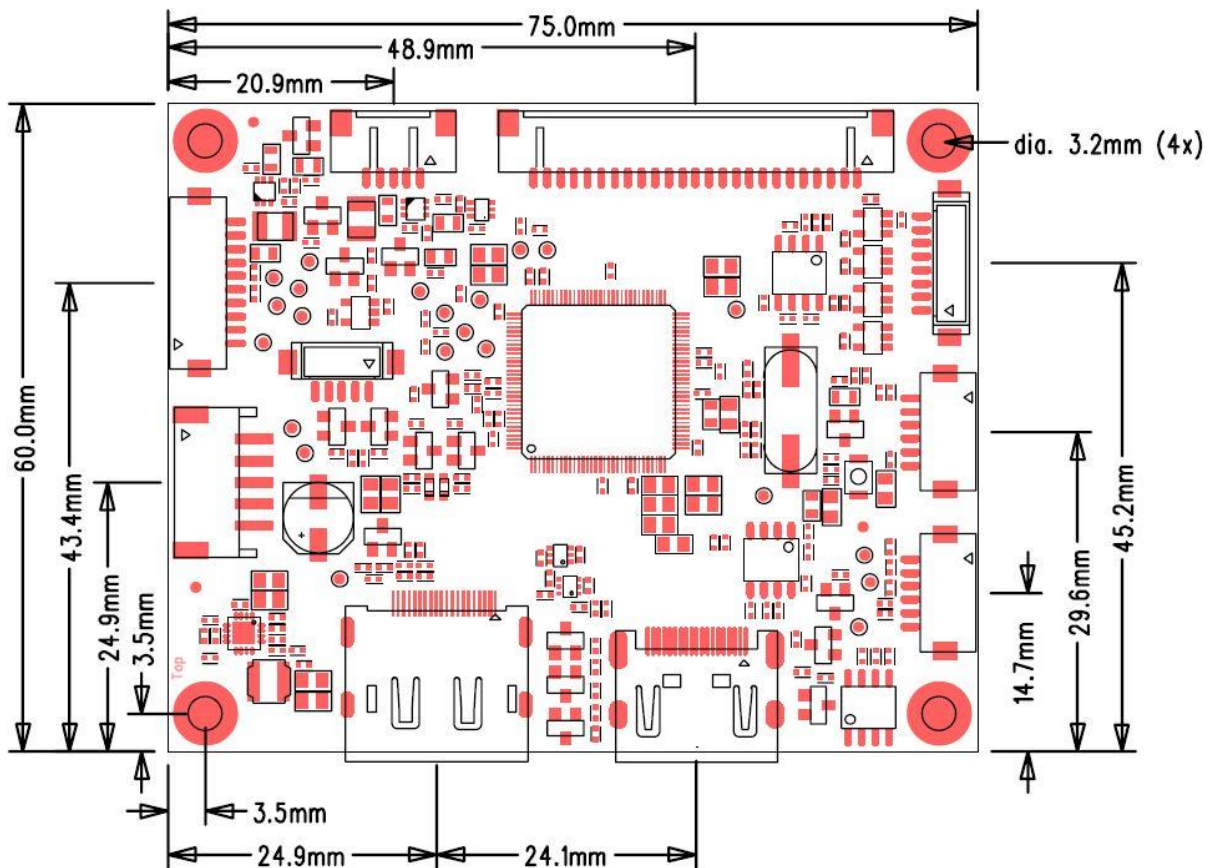

## 11 Connector Overview

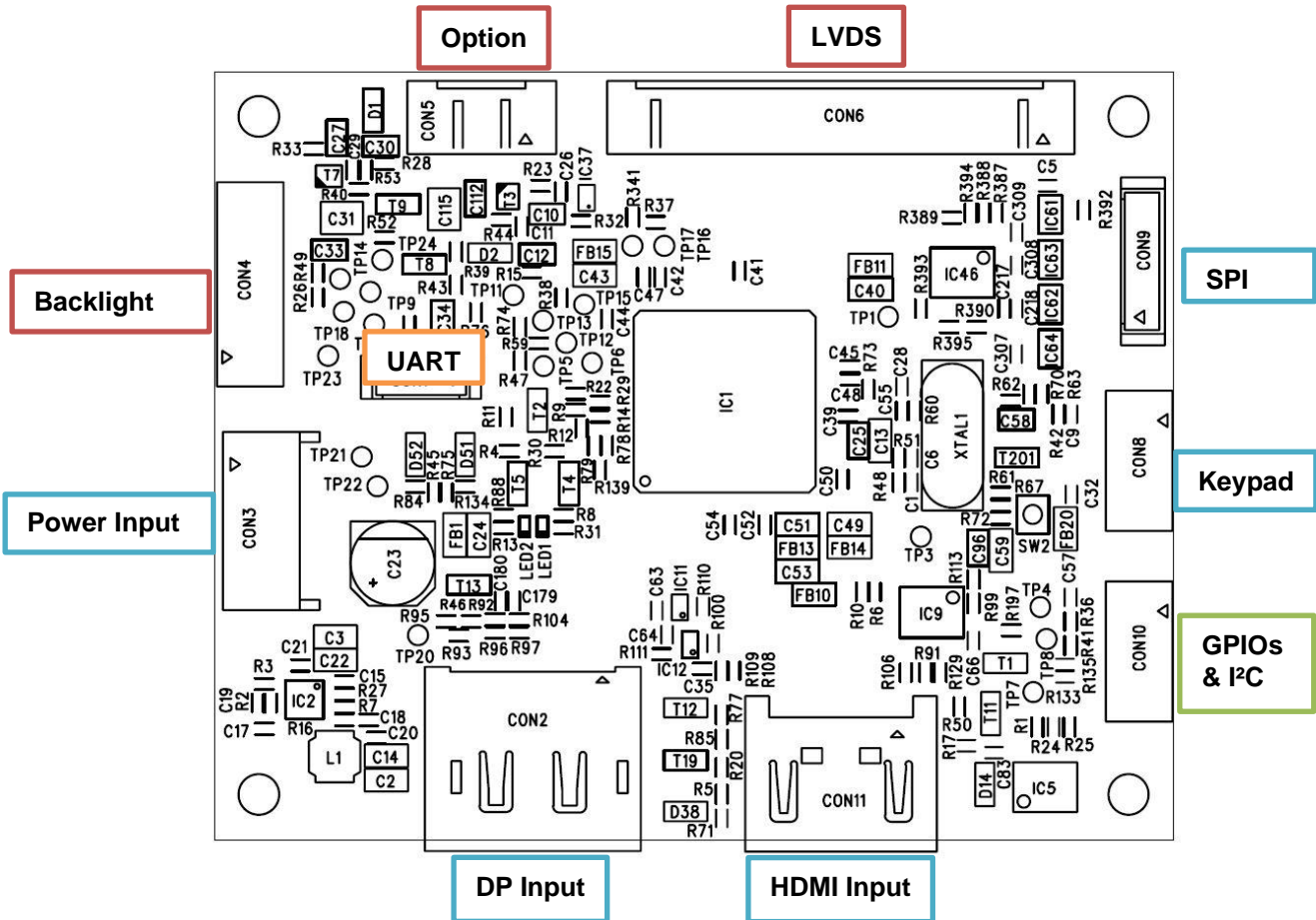

Connectors	Description	Type (Ref only)	Manufacture (Ref only)
CON11	HDMI Input	47151-1001	Molex
CON2	DisplayPort Input	47272-0001	Molex
CON3	Power Input	S5B-PH-SM4-TB	JST
CON4	Backlight Connector	DF13-10P-1.25H	Hirose
CON5	Additional LVDS power+ option	DF14-5P-1.25H	Hirose
CON6	Dual LVDS Connector	DF14-25P-1.25H	Hirose
CON7	UART	DF13-5P-1.25V (20)	Hirose
CON8	Keypad	DF13-6P-1.25H	Hirose
CON9	SPI Programming Header	DF13-8P-1.25V (20)	Hirose
CON10	GPIO & I <sup>2</sup> C Header	DF13-6P-1.25H	Hirose

## 11.1 Input Connectors

HDMI CONNECTOR CON11		
Pin	Signal	Description
1	TMDS2+	Differential TMDS Data 2+
2	GND	Ground
3	TMDS2-	Differential TMDS Data 2-
4	TMDS1+	Differential TMDS Data 1+
5	GND	Ground
6	TMDS1-	Differential TMDS Data 1-
7	TMDS0+	Differential TMDS Data 0+
8	GND	Ground
9	TMDS0-	Differential TMDS Data 0-
10	TMDSCLK+	Differential TMDS Clock+

Pin	Signal	Description
11	GND	Ground
12	TMDSCLK-	Differential TMDS Clock-
13	CEC	Consumer Electronic Control
14	Reserved	
15	HDMI_SCL	DDC Clock
16	HDMI_SDA	DDC Data
17	HDMI_PLUG	Connect it to GND for cable detection
18	HDMI_VCC	+5V
19	Hot Plug	Hot Plug Detection

DISPLAYPORT CONNECTOR CON2		
Pin	Signal	Description
1	DP3-_IN	Pair-3 negative
2	GND	Ground
3	DP3+_IN	Pair-3 positive
4	DP2-_IN	Pair-2 negative
5	GND	Ground
6	DP2+_IN	Pair-2 positive
7	DP1-_IN	Pair-1 negative
8	GND	Ground
9	DP1+_IN	Pair-1 positive
10	DPO-_IN	Pair-0 negative

Pin	Signal	Description
11	GND	Ground
12	DPO+_IN	Pair-0 positive
13	GND	Ground
14	GND	Ground
15	DPA+_IN	Aux channel positive
16	GND	Ground
17	DPA-_IN	Aux channel negative
18	HPD	Hot Plug Detect
19	Power Return	Return for +3.3V
20	+3.3V_DP	DisplayPort +3.3V

POWER CONNECTOR CON3		
Pin	Signal	Description
1	V_BKLT	Backlight Power Supply
2	GND	Ground
3		
4	+3.3V_INPUT	Logic Power Supply +3.3V
5	VCC	Panel Power Supply Input (Voltage Level +3.3V, 5V or 12V)

UART CONNECTOR- CON7		
Pin	Signal	Description
1	TX	Serial Output
2	RX	Serial Input
3	+3.3V	3.3V Power Supply
4	--	Not Connected
5	GND	Ground

Keypad CON8		
Pin	Signal	Description
1	LBADC_IN1	Low Bandwidth ADC
2	GND	Ground
3	LED_RED	Status LED red (Sleep Mode)
4	LED_GREEN	Status LED green (signal good)
5	GND	Ground
6	+3.3V	+3.3V power

SPI PROGRAMMING HEADER CON9		
Pin	Signal	Description
1	SPI_PROG_EN#	Enable Signal
2	SPI_CLK_FLASH	SPI Clock
3	SPI_SI_FLASH	SPI_SI
4	SPI_SO_FLASH	SPI_SO

Pin	Signal	Description
5	SPI_CS_FLASH	SPI_CS
6	MSTAR_RESET_N	MSTAR_RESET_N
7	GND	GND
8	+3.3V Output	+3.3V Output

## 11.2 Output Connectors

BACKLIGHT CONNECTOR CON4		
Pin	Signal	Description
1	SV_BKLT	Backlight power supply
2	GND	Ground
3	BKLT_EN	Enable backlight signal
4	BRT_ADJ	Brightness control signal (2)
5	EXT_GPIO_2	External GPIO 2 (1)

Pin	Signal	Description
6	EXT_GPIO_3	External GPIO 3 (1)
7	SV_BKLT	Backlight power supply
8	SV_BKLT	
9	GND	Ground
10	GND	

(1) External GPIO pins are open drain, pulled up to 3.3V by 4.7kΩ resistor.

(2) From HW Version PR-01-431\_A2 on a 75R Serial resistor has been added to avoid overshooting.

Additional LVDS power+ option CON5		
Pin	Signal	Description
1	LVDS_OPT_0	FW selectable option pin +3.3V / GND
2	SVCC	Switched panel power supply +3.3V/ +5V/ +12V
3	SVCC	

Pin	Signal	Description
4	GND	Ground
5	GND	Ground

LVDS CONNECTOR CON6		
Pin	Signal	Description
1	SVCC	Switched panel power supply +3.3V/ +5V/ +12V
2		
3	GND	Ground
4		
5	TXB3+	LVDS data 1st pixel
6	TXB3-	LVDS data 1st pixel
7	TXBCL+	LVDS clock 1st pixel
8	TXBCL-	LVDS clock 1st pixel
9	TXB2+	LVDS data 1st pixel
10	TXB2-	LVDS data 1st pixel
11	TXB1+	LVDS data 1st pixel
12	TXB1-	LVDS data 1st pixel
13	TXB0+	LVDS data 1st pixel

Pin	Signal	Description
14	TXB0-	LVDS data 1st pixel
15	TXA3+	LVDS data 2nd pixel
16	TXA3-	LVDS data 2nd pixel
17	TXACL+	LVDS clock 2nd pixel
18	TXACL-	LVDS clock 2nd pixel
19	TXA2+	LVDS data 2nd pixel
20	TXA2-	LVDS data 2nd pixel
21	TXA1+	LVDS data 2nd pixel
22	TXA1-	LVDS data 2nd pixel
23	TXA0+	LVDS data 2nd pixel
24	TXA0-	LVDS data 2nd pixel
25	BKLT_EN	Enable backlight signal

### 11.3 I/O Connector

There are 2 GPIOs connected to CN9, which can be configured as either input or output, using custom firmware.

There also is an I2C connection, for control of external I2C devices, temperature- and/ or ambient-light sensors.

GPIO & I2C Header CON10		
Pin	Signal	Description
1	+3.3V	3.3V power supply
2	EXT_GPIO_0	External GPIO 0 (1)
3	EXT_GPIO_1	External GPIO 1 (1) (2)

Pin	Signal	Description
4	SCL	I2C Clock
5	SDA	I2C Data
6	GND	Ground

(1) External GPIO pins are open drain, pulled up to 3.3V by 4.7kΩ resistor.



## 12 Accessories

### 12.1 Light Sensor ZU-02-412

This light sensor can be connected to the scaler chip to automatically adjust the panel brightness according to the ambient light.

Fitting cable to CON10: **KA-31-358**.



### 12.2 Temperature Sensor ZU-02-389

A temperature sensor is available to check the temperature of a TFT panel or any other hardware.

FW support is provided upon request.

Fitting cable to CON10: **KA-31-359**

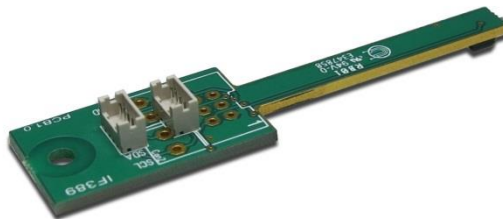

**Remark:** When both light and temperature sensors are used, please connect light sensor ZU-02-412 directly to temperature sensor ZU-02-389 via cable: **KA-30-959**

### 12.3 Frozen Screen Detector ZU-02-512

A Frozen-Screen Detector can be connected to CON10. This feature can detect if the content of the display is being updated.

FW support is provided upon request. Also refer to datasheet and technical details for this feature. Please contact Distec customer service if you need more information.

Fitting cable to CON10: **KA-31-358**

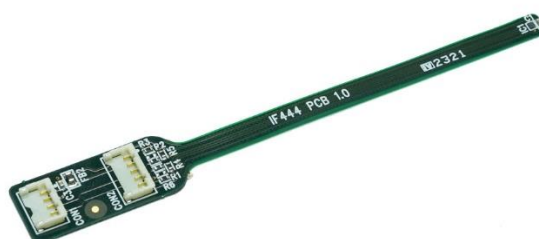

## 13 Programming, configuration and ROSD via serial port

*Preconfigured ("ready to run") HW is also available, please contact customer service for information.*

Please refer to MStarRover Manual for details of configuration.

- If PrismaMINI-HDMI-DP-II is blank and without any Firmware the DediProg SF100 SPI programmer is mandatory for initial flashing of Firmware. After that Firmware can be flashed also via Serial/USB Port.
- For configuration of Display settings/EDID configuration or for usage of ROSD its sufficient to use the USB to Serial UART Converter IF430.

### 13.1 HW requirements

- Standard PC with Windows OS
- 1x USB port for serial programmer
- 1x USB port for DediProg SF100 SPI programmer
- 

DediProg SF100 SPI Programmer (optional) *		
Part#	Part description	Additional info
KI-90-035**	DediProg SF100 USB-SPI Programmer	
KI-90-035**	ZU-02-399 IF399-00-SPI Buffer interface for PIIIA	
KI-90-035**	KA-30-377 Cable SPI-Buffer-Interface 8pol. 150mm	Cable between SPI Buffer <b>CON1</b> and SPI connector <b>CON9</b>

- (\*) mandatory for initial FW-flashing of blank PrismaMINI-HDMI-DP-II
- (\*\*) KI-90-035 consists of DediProg SF100 USB-SPI Programmer, buffer interface and cable (as shown below).



USB to serial adapter		
Part#	Part description	Additional info
ZU-02-430	IF430-00 USB to Serial UART Converter	RS232 programming adapter
KA-30-101	Cable Service & Remote 80cm	Cable from RS-232 adapter to PrismaMINI-HDMI-DP-II(CON7)
KA-30-051	USB-Cable, Highspeed, type A/B m/m 2m	



### 13.2 ROSD Protocol

PrismaMINI-HDMI-DP-II can be fully controlled via Remote OSD Protocol.

Details can be found in "MStar-ROSD.pdf" or contact Distec customer service.

Our company network supports you worldwide with offices in Germany, Austria, Switzerland, the UK and the USA.  
For more information please contact:

## Headquarters

Germany



**FORTEC**  
GROUP

**FORTEC Elektronik AG**  
Augsburger Str. 2b  
82110 Germering

Phone: +49 89 894450-0  
E-Mail: [info@fortecag.de](mailto:info@fortecag.de)  
Internet: [www.fortecag.de](http://www.fortecag.de)

---

## Fortec Group Members

Austria



**FORTEC**  
INTEGRATED

**FORTEC Integrated GmbH Office Vienna**  
Nuschinggasse 12  
1230 Wien

Phone: +43 1 8673492-0  
E-Mail: [info@fortec-integrated.de](mailto:info@fortec-integrated.de)  
Internet: [www.fortec-integrated.de](http://www.fortec-integrated.de)

Germany



**FORTEC**  
INTEGRATED

**FORTEC Integrated GmbH**  
Augsburger Str. 2b  
82110 Germering

Phone: +49 89 894363-0  
E-Mail: [info@fortec-integrated.de](mailto:info@fortec-integrated.de)  
Internet: [www.fortec-integrated.de](http://www.fortec-integrated.de)

Switzerland



**FORTEC**  
SWITZERLAND

**FORTEC Switzerland AG**  
Bahnhofstraße 3  
5436 Würenlos

Phone: +41 44 7446111  
E-Mail: [info@fortec.ch](mailto:info@fortec.ch)  
Internet: [www.fortec.ch](http://www.fortec.ch)

United Kingdom



**FORTEC**  
UNITED KINGDOM

**FORTEC Technology UK Ltd.**  
Osprey House, 1 Osprey Court  
Hinchingsbrook Business Park  
Huntingdon, Cambridgeshire, PE29 6FN

Phone: +44 1480 411600  
E-Mail: [info@fortec.uk](mailto:info@fortec.uk)  
Internet: [www.fortec.uk](http://www.fortec.uk)

USA



**FORTEC**  
UNITED STATES

**FORTEC US, Corp.**  
87 Raynor Avenue, Unit 1  
Ronkonkoma, NY 11779

Phone: +1 631 5804360  
E-Mail: [info@fortec.us](mailto:info@fortec.us)  
Internet: [www.fortec.us](http://www.fortec.us)