



OUR GLOBAL
COMPETENCE
CENTRES

 APOLLO DISPLAY
TECHNOLOGIES



 DISTEC



 DISPLAY
TECHNOLOGY



Datasheet

AUO

P320HVN03.0

UP-02-153



The information contained in this document has been carefully researched and is, to the best of our knowledge, accurate. However, we assume no liability for any product failures or damages, immediate or consequential, resulting from the use of the information provided herein. Our products are not intended for use in systems in which failures of product could result in personal injury. All trademarks mentioned herein are property of their respective owners. All specifications are subject to change without notice.

Model Name: P320HVN03.0

Issue Date: 2015/12/28

() Preliminary Specifications

(*) Final Specifications

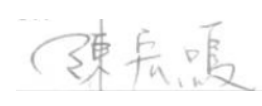
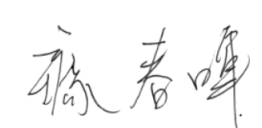
Customer Signature	Date	AUO	Date
Approved By		Approval By PM Director Kelly Kao	
Note		Reviewed By RD Director Eugene CC Chen	
		Reviewed By Project Leader Alex HM Chen	
		Prepared By PM Bryan Chu	

Contents

1. General Description	4
1.1. Display Characteristics	4
1.2. Optical Characteristics.....	5
1.3. Mechanical Characteristics.....	8
1.3.1. Placement Suggestions	8
2. Absolute Maximum Ratings	12
3. Electrical Specification	13
3.1. Electrical Characteristics	13
3.1.1. DC Characteristics (Ta = 25 ± 2 °C)	13
3.1.2. AC Characteristics (Ta = 25 ± 2 °C)	14
3.1.3. Driver Characteristics	14
3.1.4. TCON Characteristics	14
3.2. Interface Connections.....	17
3.3. Signal Timing Specification	21
3.4. Signal Timing Waveforms	22
3.5. Color Input Data Reference	23
3.6. Power Sequence for LCD	25
3.7. Backlight Specification.....	26
3.7.1. Electrical specification (Ta = 25 ± 2 °C)	26
3.7.2. Input Pin Assignment	27
3.7.3. Power Sequence for Backlight.....	28
3.7.4. LED Operating Life Time	29
4. Reliability Test Items	30
5. International Standard	31
5.1. Safety	31
5.2. EMC	31
6. Packing	32
6.1. Definition of Label.....	32
6.2. Packing Methods	33
6.3. Pallet and Shipment Information	34
7. Precautions	35
7.1. Mounting Precautions.....	35
7.2. Operating Precautions.....	35
7.3. Operating Condition for Public Information Display	36
7.4. Electrostatic Discharge Control	36
7.5. Precautions for Strong Light Exposure	36
7.6. Storage	36
7.7. Handling Precautions for Protection Film	37

Record of Revision

Version	Date	Page	Description
0.0	2015/11/11		1 st release
1.0	2015/12/16		Change to new template
2.0	2015/12/28	5	Correct "Contrast ratio" to 3000

AUO Confidential For DD Internal Use Only On 2016/01/14

1. General Description

This specification applies to the 32 inch Color TFT-LCD Module P320HVN03.0. This LCD module has a TFT active matrix type liquid crystal panel 1920x1080 pixels, and diagonal size of 31.5 inch. This module supports 1920x1080 mode. Each pixel is divided into Red, Green and Blue sub-pixels or dots which are arranged in vertical stripes. Gray scale or the brightness of the sub-pixel color is determined with 8-bits or 10-bits gray scale signal for each dot.

The P320HVN03.0 has been designed to apply the 2 channel LVDS interface method. It is intended to support displays where high brightness, wide viewing angle. High Tni (110) liquid crystal is also applied on this model to enhance the sunlight readability.

* General Information

1.1. Display Characteristics

Items	Specification	Unit	Note
Active Screen Size	31.5	inch	
Display Area	698.4 (H) x 392.85(V)	mm	
Outline Dimension	719.2(H) x 413.7(V) x 27.4 (D)	mm	D: front bezel to DB cover
Driver Element	a-Si TFT active matrix		
Bezel Opening	703.4(H) x 397.9(V)	mm	
Display Colors	8 or 10 bits	Colors	
Number of Pixels	1,920x1,080	Pixel	
Pixel Pitch	0.3637 (H) x 0.3637 (W)	mm	
Pixel Arrangement	RGB vertical stripe		
Display Operation Mode	Normally Black		
Surface Treatment	Anti-Glare, 3H		Haze=44%
Rotate Function	Unachievable		Note 1
Display Orientation	Portrait/Landscape Enabled		Note 2

Note 1: Rotate Function refers to LCD display could be able to rotate. This function does not work in this model.

Note 2: Please refer to 5.1 Placement Suggestions.

1.2. Optical Characteristics

Optical characteristics are determined on the back-light of measured unit is 'ON' and stabilized after 45~60 minutes in a dark environment at 25°C. The values are specified at 50cm distance from the LCD surface at a viewing angle of φ and θ equal to 0°.

Fig.1 presents additional information concerning the measurement equipment and method.

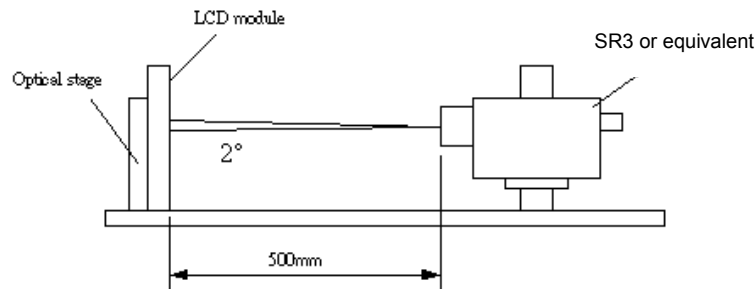

Parameter	Symbol	Values			Unit	Notes
		Min.	Typ.	Max		
Contrast Ratio	CR	2400	3000	--		1
Surface Luminance (White)	$L_{WH}(2D)$	800	1000	--	cd/m ²	2
Luminance Variation	$\delta_{WHITE(9P)}$	--	--	1.33		3
Response Time (G to G)	T_{γ}	--	8	10	ms	4
Color Gamut	NTSC		72		%	
Color Coordinates						
	Red	R_x		0.652	Typ.-0.03	Typ.+0.03
		R_y		0.332		
	Green	G_x		0.300		
		G_y		0.623		
	Blue	B_x		0.150		
		B_y		0.065		
	White	W_x		0.28		
	W_y		0.29			
Viewing Angle						
	x axis, right($\varphi=0^\circ$)	θ_r	--	89	--	degree
	x axis, left($\varphi=180^\circ$)	θ_l	--	89	--	degree
	y axis, up($\varphi=90^\circ$)	θ_u	--	89	--	degree
	y axis, down ($\varphi=270^\circ$)	θ_d	--	89	--	degree

Note:

1. Contrast Ratio (CR) is defined mathematically as:

$$\text{Contrast Ratio} = \frac{\text{Surface Luminance of } L_{\text{on5}}}{\text{Surface Luminance of } L_{\text{off5}}}$$

2. Surface luminance is luminance value at point 5 across the LCD surface 50cm from the surface with all pixels displaying white. From more information see FIG 2. LED current I_F = typical value (without driver board), LED input $V_{\text{DDB}} = 24\text{V}$, I_{DDB} = Typical value (with driver board), $L_{\text{WH}} = L_{\text{on5}}$ where L_{on5} is the luminance with all pixels displaying white at center 5 location.

3. The variation in surface luminance, δ_{WHITE} is defined (center of Screen) as:

$$\delta_{\text{WHITE(9P)}} = \frac{\text{Maximum}(L_{\text{on1}}, L_{\text{on2}}, \dots, L_{\text{on9}})}{\text{Minimum}(L_{\text{on1}}, L_{\text{on2}}, \dots, L_{\text{on9}})}$$

4. Response time T is the average time required for display transition by switching the input signal for five luminance ratio (0%,25%,50%,75%,100% brightness matrix) and is based on $F_v = 60\text{Hz}$ to optimize.

Measured Response Time		Target				
		0%	25%	50%	75%	100%
Start	0%		0% to 25%	0% to 50%	0% to 75%	0% to 100%
	25%	25% to 0%		25% to 50%	25% to 75%	25% to 100%
	50%	50% to 0%	50% to 25%		50% to 75%	50% to 100%
	75%	75% to 0%	75% to 25%	75% to 50%		75% to 100%
	100%	100% to 0%	100% to 25%	100% to 50%	100% to 75%	

T is determined by 10% to 90% brightness difference of rising or falling period. (As illustrated)

The response time is defined as the following figure and shall be measured by switching the input signal for “any level of gray(bright) “ and “any level of gray(dark)”.

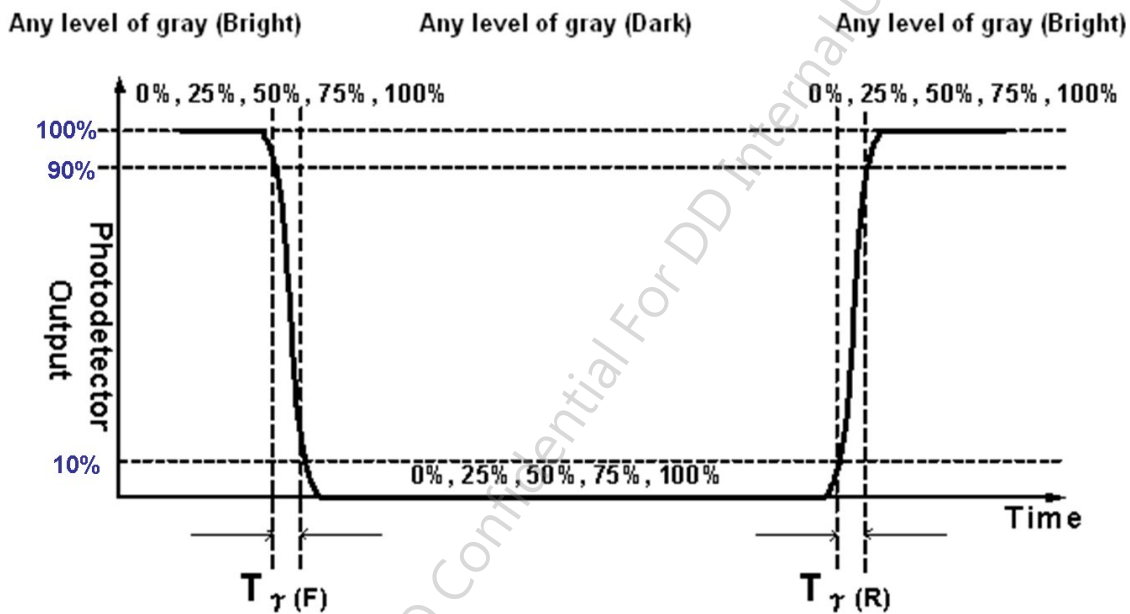
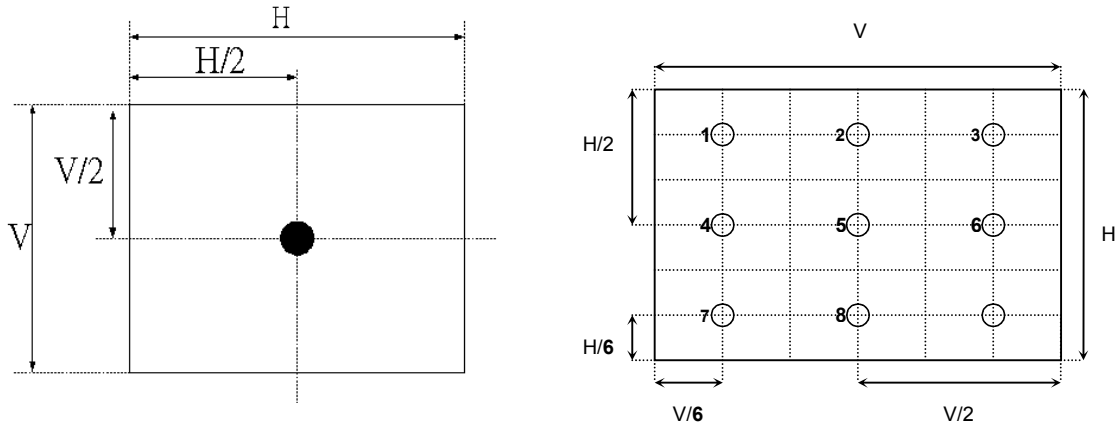
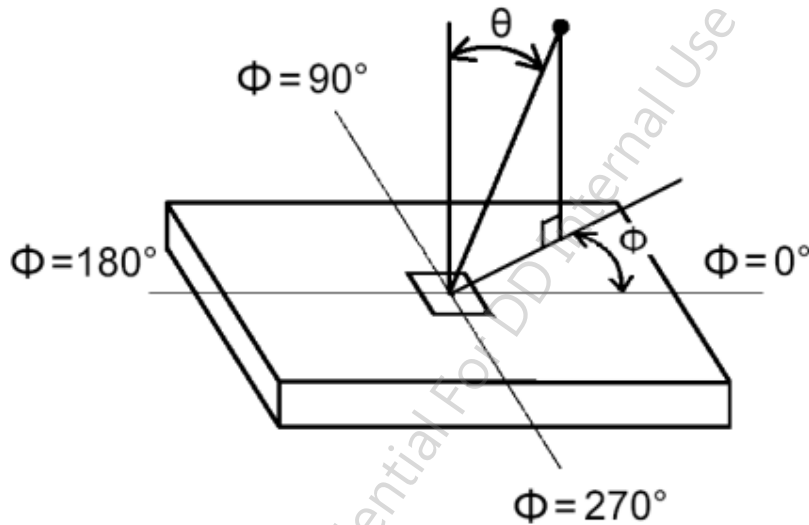

FIG. 2 Luminance



5. Viewing angle is the angle at which the contrast ratio is greater than 10. The angles are determined for the horizontal or x axis and the vertical or y axis with respect to the z axis which is normal to the LCD surface. For more information see FIG3.

FIG.3 Viewing Angle



1.3. Mechanical Characteristics

The contents provide general mechanical characteristics for the model P320HVN03.0 In addition the figures in the next page are detailed mechanical drawing of the LCD.

Item	Dimension	Unit	Note	
Outline Dimension	Horizontal	719.2	mm	
	Vertical	413.7	mm	
	Depth (Dmin)	10.8	mm	front bezel to back bezel
	Depth (Dmax)	27.4	mm	to DB cover
Weight	4910	G	w/ DB	

1.3.1. Placement Suggestions

1. Landscape Mode: The default placement is T-Con Side on the lower side and the image is shown upright via viewing from the front.
2. Portrait Mode: The default placement is that T-Con side has to be placed on the left side via viewing from the front.

Landscape (Front view)

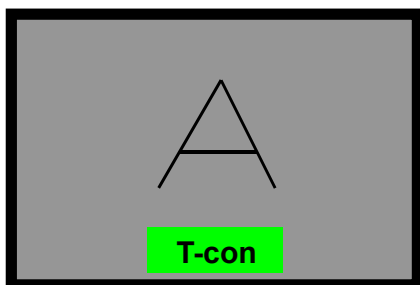

Portrait (Front view)

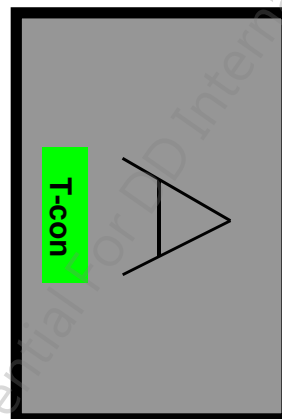

Front View

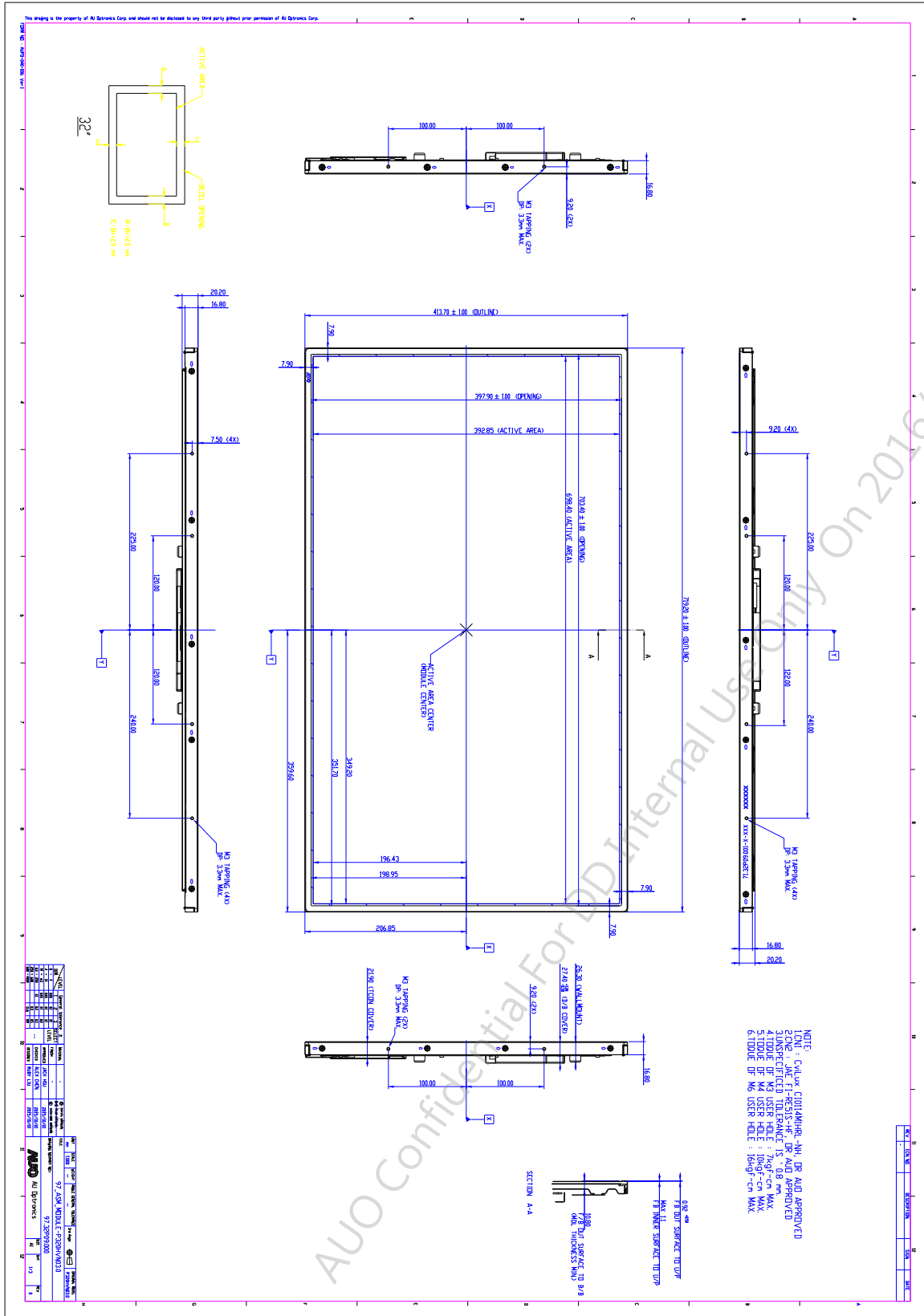

Back View 2

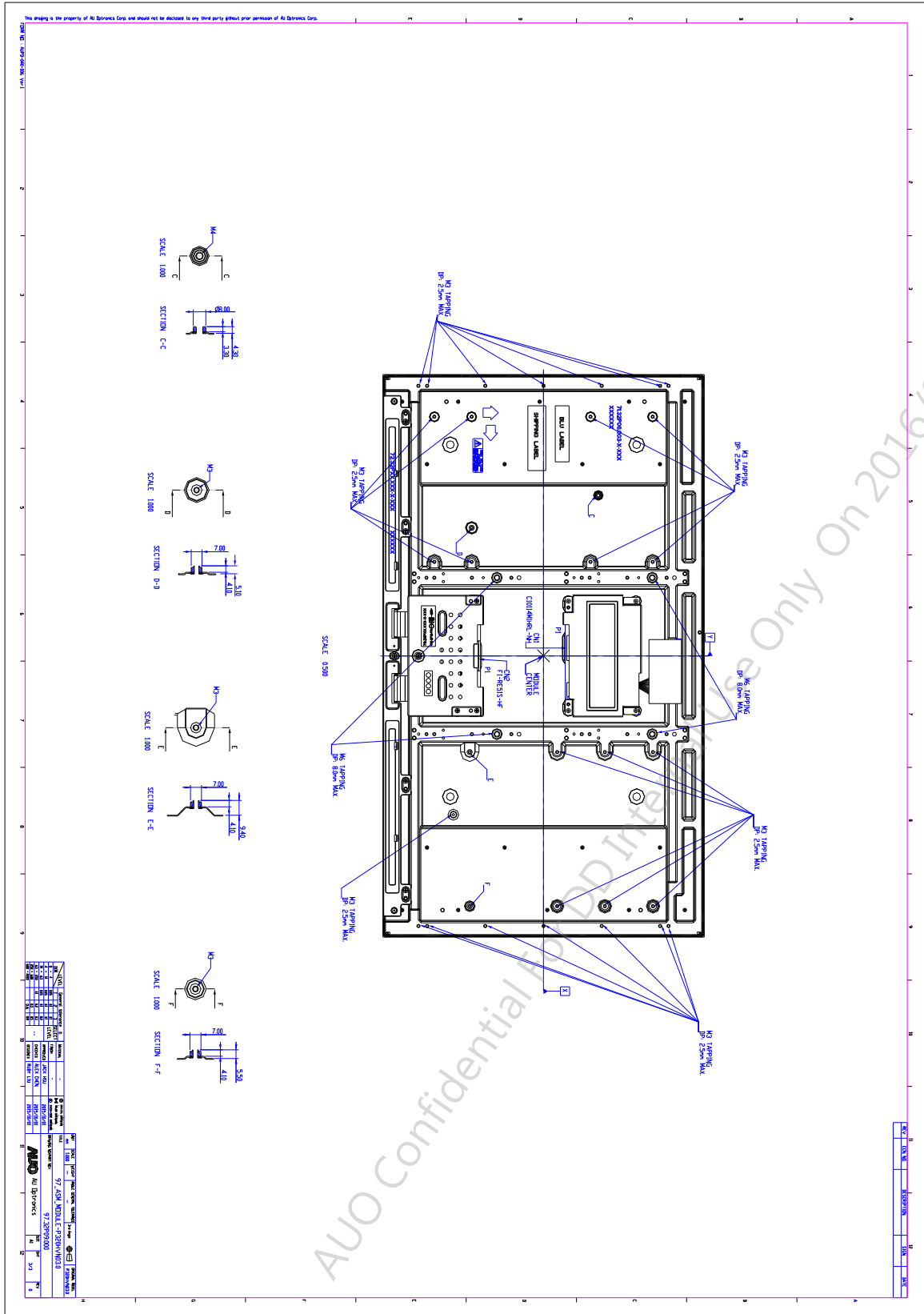

2. Absolute Maximum Ratings

The followings are maximum values which, if exceeded, may cause faulty operation or damage to the unit

Item	Symbol	Min	Max	Unit	Conditions
Logic/LCD Drive Voltage	Vcc	-0.3	14	[Volt]	Note 1
Input Voltage of Signal	Vin	-0.3	3.6	[Volt]	Note 1
Operating Temperature	TOP	0	+50	[°C]	Note 2
Operating Humidity	HOP	10	90	[%RH]	Note 2
Storage Temperature	TST	-20	+60	[°C]	Note 2
Storage Humidity	HST	10	90	[%RH]	Note 2
Panel Surface Temperature	PST		70	[°C]	Note 3

Note 1: Duration:50 msec.

Note 2 : Maximum Wet-Bulb should be 39□ and No condensation.

The relative humidity must not exceed 90% non-condensing at temperatures of 40□ or less. At temperatures greater than 40□, the wet bulb temperature must not exceed 39□.

Note 3: Surface temperature is measured at 50 Dry condition

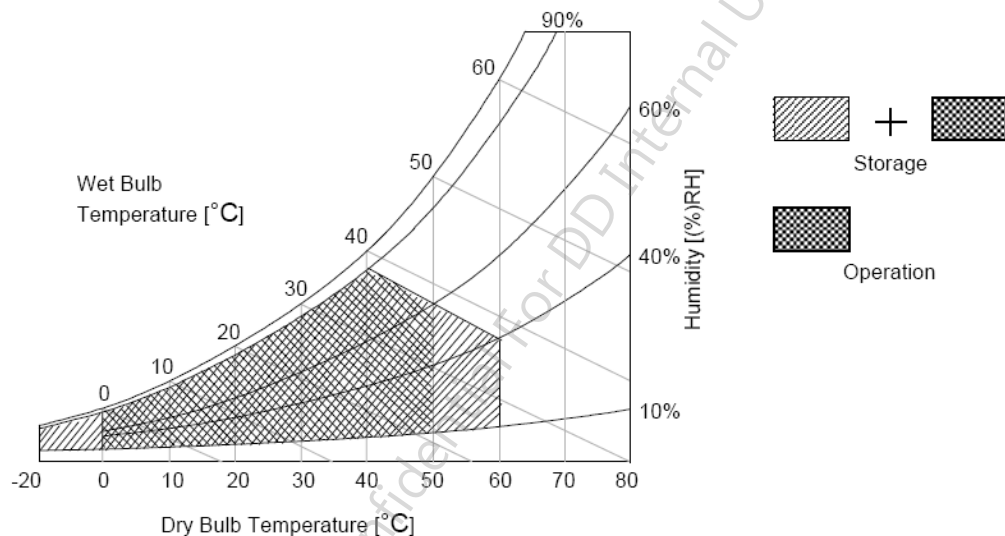

3. Electrical Specification

The **P320HVN03.0** requires two power inputs. One is employed to power the LCD electronics and to drive the TFT array and liquid crystal. The other is to power Back Light Unit.

3.1. Electrical Characteristics

3.1.1. DC Characteristics (Ta = 25 ± 2 °C)

Parameter		Symbol	Value			Unit	Note
			Min.	Typ.	Max		
LCD							
Power Supply Input Voltage		V _{DD}	10.8	12	13.2	V _{DC}	
Power Supply Input Current		I _{DD}	--	0.36	0.33	A	1
Power Consumption		P _C	--	4.32	4.35	Watt	1
Inrush Current		I _{RUSH}	--	--	4	A	2
Permissible Ripple of Power Supply Input Voltage		V _{RP}	--	--	V _{DD} * 5%	mV _{pk-pk}	3
LVDS Interface	Input Differential Voltage	V _{ID}	200	400	600	mV _{DC}	4
	Differential Input High Threshold Voltage	V _{TH}	+100	--	+300	mV _{DC}	4
	Differential Input Low Threshold Voltage	V _{TL}	-300	--	-100	mV _{DC}	4
	Input Common Mode Voltage	V _{ICM}	1.1	1.25	1.4	V _{DC}	4
CMOS Interface	Input High Threshold Voltage	V _{IH} (High)	2.7	--	3.3	V _{DC}	5
	Input Low Threshold Voltage	V _{IL} (Low)	0	--	0.6	V _{DC}	5

3.1.2. AC Characteristics (Ta = 25 ± 2 °C)

Parameter		Symbol	Value			Unit	Note
			Min.	Typ.	Max		
LVDS Interface	Receiver Clock : Spread Spectrum Modulation range	Fclk_ss	Fclk -3%	--	Fclk +3%	MHz	7
	Receiver Clock : Spread Spectrum Modulation frequency	Fss	30	--	200	KHz	7
	Receiver Data Input Margin Fclk = 85 MHz Fclk = 65 MHz	tRMG	-0.4 -0.5	-- --	0.4 0.5	ns	8

3.1.3. Driver Characteristics

Item	Symbol	Min	Max	Unit	condition
Driver Surface Temperature	DST		100	[]	Note

Note : Any point on the driver surface must be less than 100 under any conditions.

3.1.4. TCON Characteristics

Item	Symbol	Min	Max	Unit	condition
TCON Surface Temperature	TST		85	[]	Note

Note: Any point on the TCON surface must be less than 85 under any conditions.

Note:

1. Test Condition:

- (1) V_{DD} = 12.0V
- (2) Fv = 60Hz
- (3) Fclk= Max freq.
- (4) Temperature = 25
- (5) Typ. Input current : White Pattern
Max. Input current: Heavy loading pattern defined by AUO
>> refer to “Section:3.3 Signal Timing Specification, Typical timing”

2. Measurement condition : Rising time = 400us

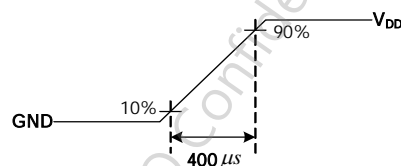

3. Test Condition:

- (1) The measure point of V_{RP} is in LCM side after connecting the System Board and LCM.
- (2) Under Max. Input current spec. condition.

4. $V_{ICM} = 1.25V$

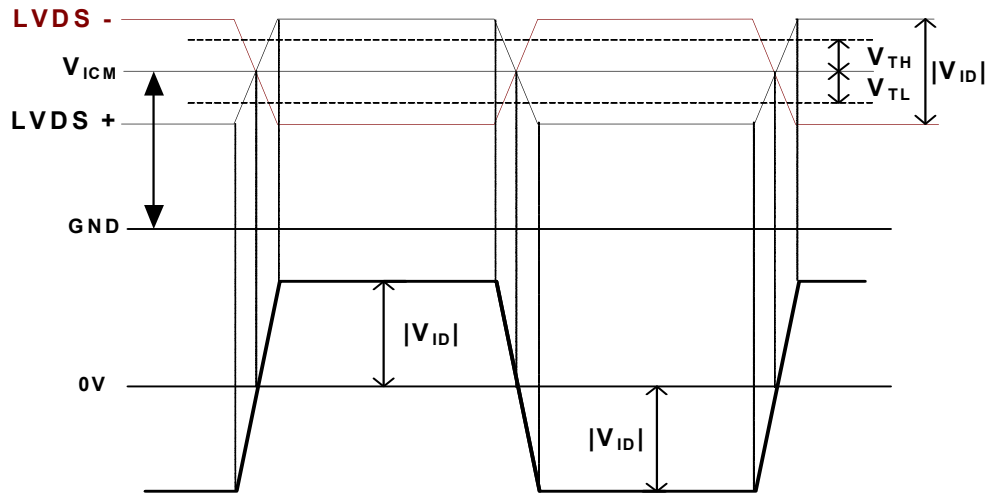

5. The measure points of V_{IH} and V_{IL} are in LCM side after connecting the System Board and LCM.

6. Input Channel Pair Skew Margin

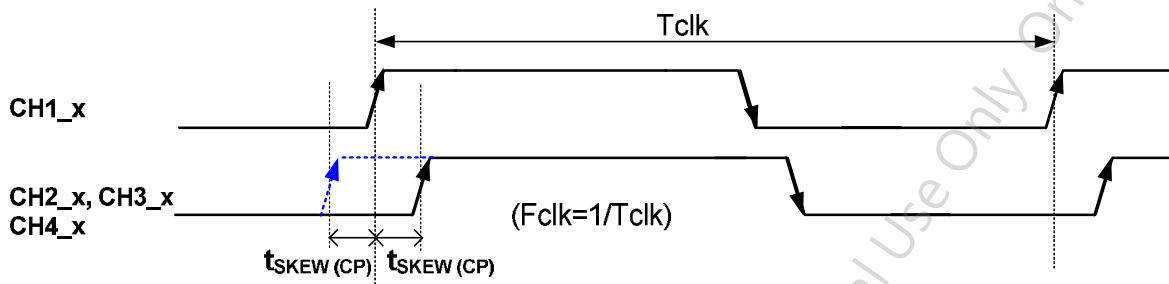

Note: $x = 0, 1, 2, 3, 4$

7. LVDS Receiver Clock SSCG (Spread spectrum clock generator) is defined as below figures

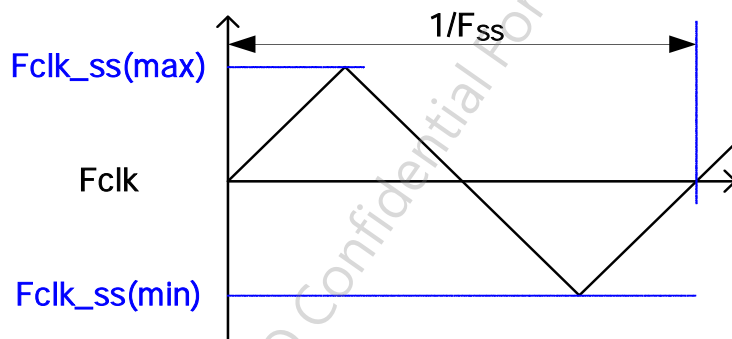

8. Receiver Data Input Margin

Parameter	Symbol	Rating			Unit	Note
		Min	Type	Max		
Input Clock Frequency	Fclk	Fclk (min)	--	Fclk (max)	MHz	T=1/Fclk
Input Data Position0	tRIP1	- tRMG	0	tRMG	ns	
Input Data Position1	tRIP0	T/7- tRMG	T/7	T/7+ tRMG	ns	
Input Data Position2	tRIP6	2T/7- tRMG	2T/7	2T/7+ tRMG	ns	
Input Data Position3	tRIP5	3T/7- tRMG	3T/7	3T/7+ tRMG	ns	
Input Data Position4	tRIP4	4T/7- tRMG	4T/7	4T/7+ tRMG	ns	
Input Data Position5	tRIP3	5T/7- tRMG	5T/7	5T/7+ tRMG	ns	
Input Data Position6	tRIP2	6T/7- tRMG	6T/7	6T/7+ tRMG	ns	

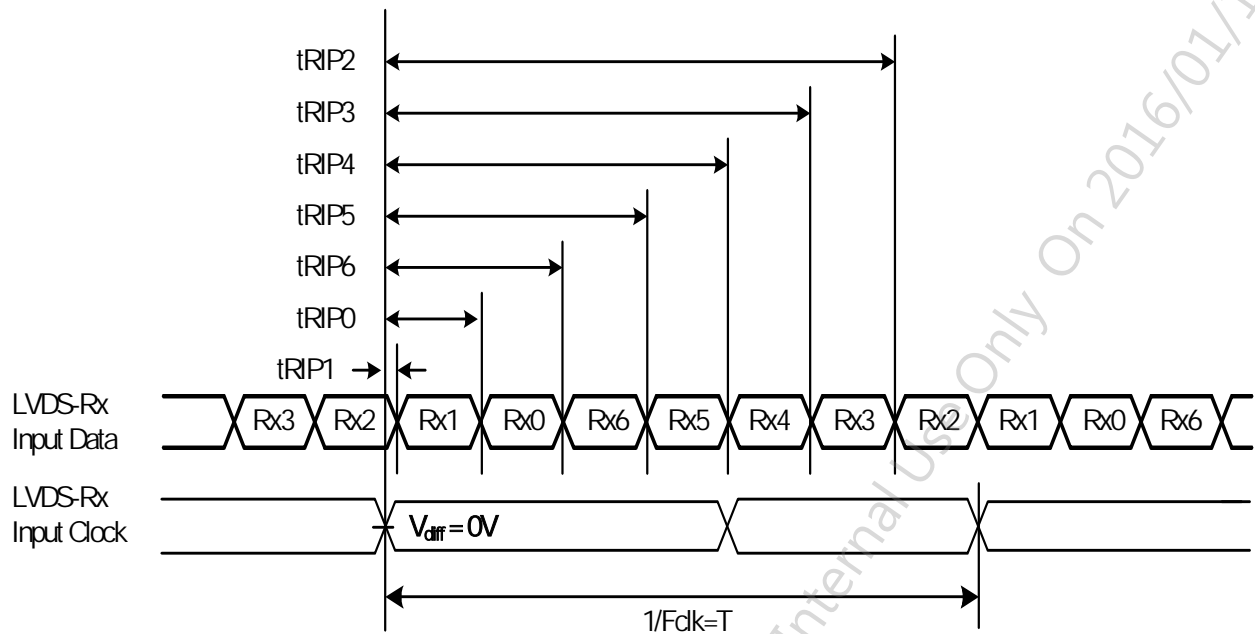

9. The relative humidity must not exceed 80% non-condensing at temperatures of 40 or less. At temperatures greater than 40, the wet bulb temperature must not exceed 39.

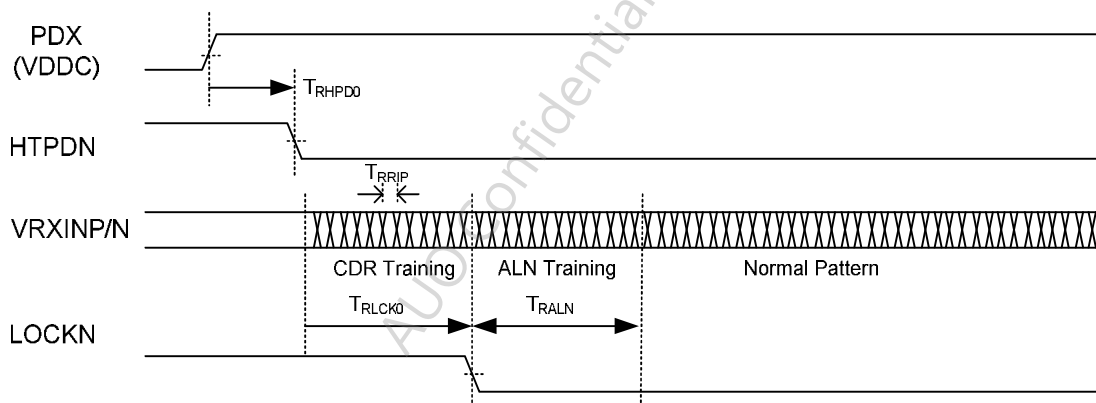

3.2. Interface Connections

- LCD connector: FI-RTE51SZ-HF, 187059-5122, 115E51-0000RA-M3-R or compatible

PIN	Symbol	Description
1	N.C.	No connection (for AUO test only. Do not connect)
2	N.C.	No connection (for AUO test only. Do not connect)
3	N.C.	No connection (for AUO test only. Do not connect)
4	N.C.	No connection (for AUO test only. Do not connect)
5	IP10B	Open/Low(GND) for 8 bits, High(3.3V) for 10 bits
6	N.C.	No connection
7	LVDS_SEL	Open/High(3.3V) for NS, Low(GND) for JEIDA
8	N.C.	No connection
9	N.C.	No connection
10	N.C.	No connection
11	GND	Ground
12	CH1_Y0-	LVDS Channel 1, Signal 0-
13	CH1_Y0+	LVDS Channel 1, Signal 0+
14	CH1_Y1-	LVDS Channel 1, Signal 1-
15	CH1_Y1+	LVDS Channel 1, Signal 1+
16	CH1_Y2-	LVDS Channel 1, Signal 2-
17	CH1_Y2+	LVDS Channel 1, Signal 2+
18	GND	Ground
19	CH1_CLK-	LVDS Channel 1, Clock -
20	CH1_CLK+	LVDS Channel 1, Clock +
21	GND	Ground
22	CH1_Y3-	LVDS Channel 1, Signal 3-
23	CH1_Y3+	LVDS Channel 1, Signal 3+
24	CH1_Y4-	LVDS Channel 1, Signal 4-
25	CH1_Y4+	LVDS Channel 1, Signal 4+
26	GND	Ground
27	GND	Ground
28	CH2_Y0-	LVDS Channel 2, Signal 0-
29	CH2_Y0+	LVDS Channel 2, Signal 0+
30	CH2_Y1-	LVDS Channel 2, Signal 1-
31	CH2_Y1+	LVDS Channel 2, Signal 1+
32	CH2_Y2-	LVDS Channel 2, Signal 2-

33	CH2_Y2+	LVDS Channel 2, Signal 2+
34	GND	Ground
35	CH2_CLK-	LVDS Channel 2, Clock -
36	CH2_CLK+	LVDS Channel 2, Clock +
37	GND	Ground
38	CH2_Y3-	LVDS Channel 2, Signal 3-
39	CH2_Y3+	LVDS Channel 2, Signal 3+
40	CH2_Y4-	LVDS Channel 2, Signal 4-
41	CH2_Y4+	LVDS Channel 2, Signal 4+
42	N.C.	No connection
43	N.C.	No connection
44	GND	Ground
45	GND	Ground
46	GND	Ground
47	N.C.	No connection
48	VDD	Power Supply, +12V DC Regulated
49	VDD	Power Supply, +12V DC Regulated
50	VDD	Power Supply, +12V DC Regulated
51	VDD	Power Supply, +12V DC Regulated

Note: N.C. : please leave this pin unoccupied. It can not be connected by any signal (Low/GND/High).

LVDS Option for 8 bits

■ LVDS Option = High/OPEN → NS

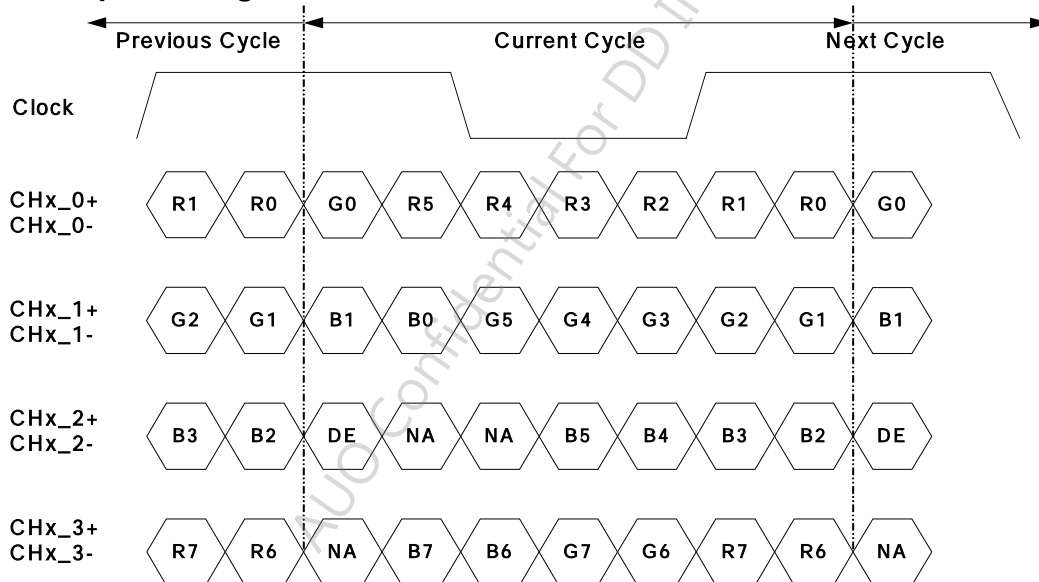

Note: x = 1, 2, 3, 4...

■ LVDS Option = Low → JEIDA

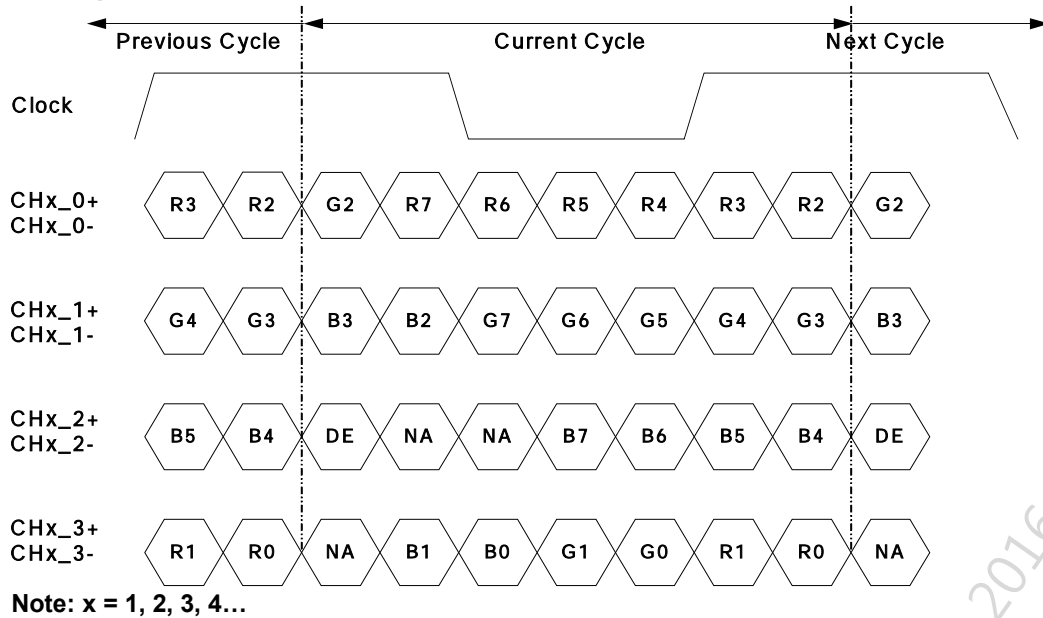

LVDS Option for 10 bits

■ LVDS Option = High/OPEN → NS

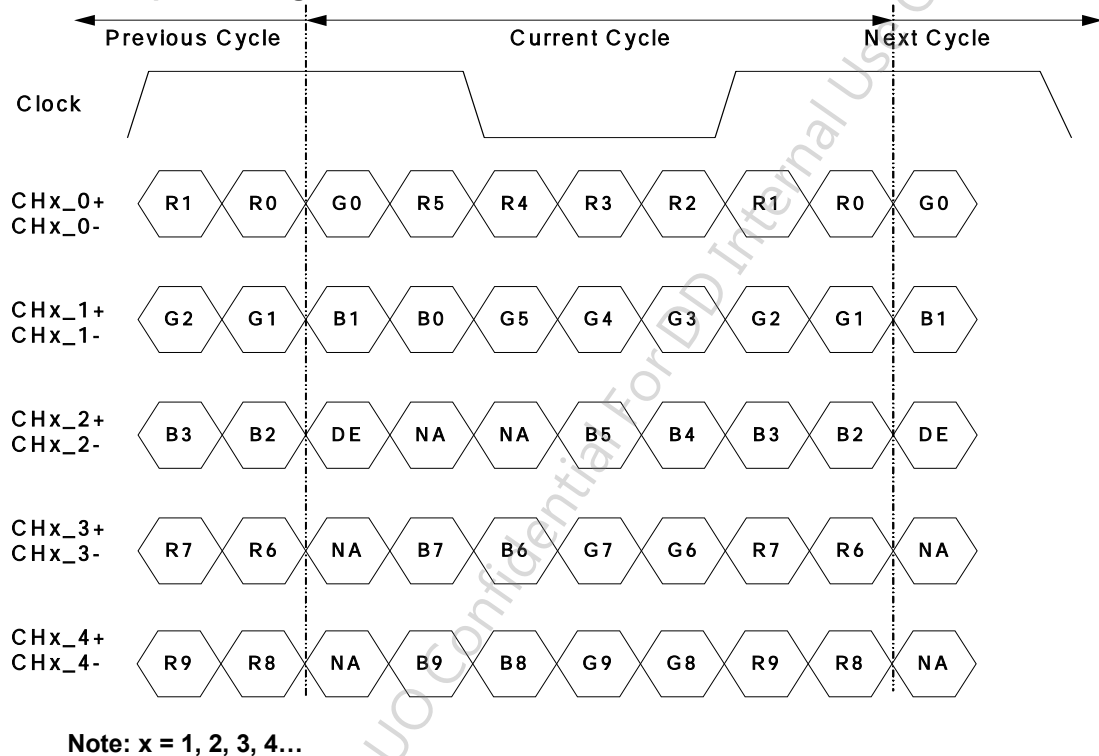

■ LVDS Option = Low → JEIDA

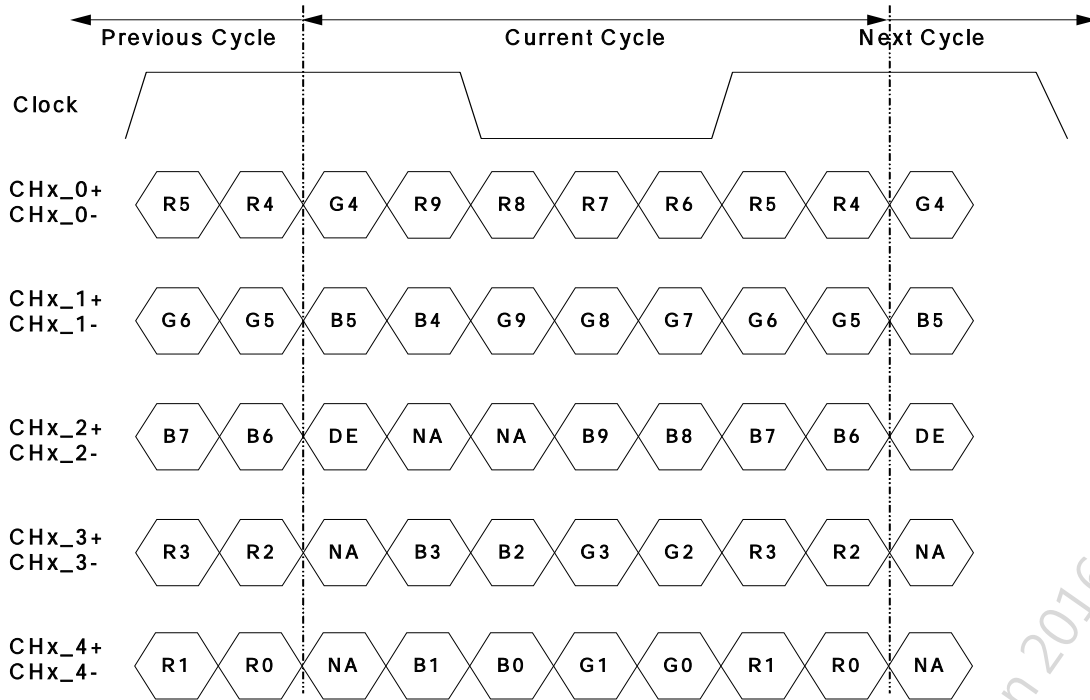

Note: x = 1, 2, 3, 4...

AUO Confidential For DD Internal Use Only On 2016/01/14

3.3. Signal Timing Specification

This is the signal timing required at the input of the user connector. All of the interface signal timing should be satisfied with the following specifications for its proper operation.

Timing Table (DE only Mode)

Signal	Item	Symbol	Min.	Typ.	Max	Unit
Vertical Section	Period	Tv	1100	1125	1480	Th
	Active	Tdisp (v)	1080			
	Blanking	Tblk (v)	20	45	400	Th
Horizontal Section	Period	Th	1030	1100	1325	Tclk
	Active	Tdisp (h)	960			
	Blanking	Tblk (h)	70	140	365	Tclk
Clock	Frequency	Fclk=1/Tclk	53	74.25	82	MHz
Vertical Frequency	Frequency	Fv	47	60	63	Hz
Horizontal Frequency	Frequency	Fh	60	67.5	73	KHz

Notes:

(1) Display position is specific by the rise of DE signal only.

Horizontal display position is specified by the rising edge of 1st DCLK after the rise of 1st DE, is displayed on the left edge of the screen.

(2) Vertical display position is specified by the rise of DE after a “Low” level period equivalent to eight times of horizontal period. The 1st data corresponding to one horizontal line after the rise of 1st DE is displayed at the top line of screen.

(3) If a period of DE “High” is less than 1920 DCLK or less than 1080 lines, the rest of the screen displays black.

(4) The display position does not fit to the screen if a period of DE “High” and the effective data period do not synchronize with each other.

3.4. Signal Timing Waveforms

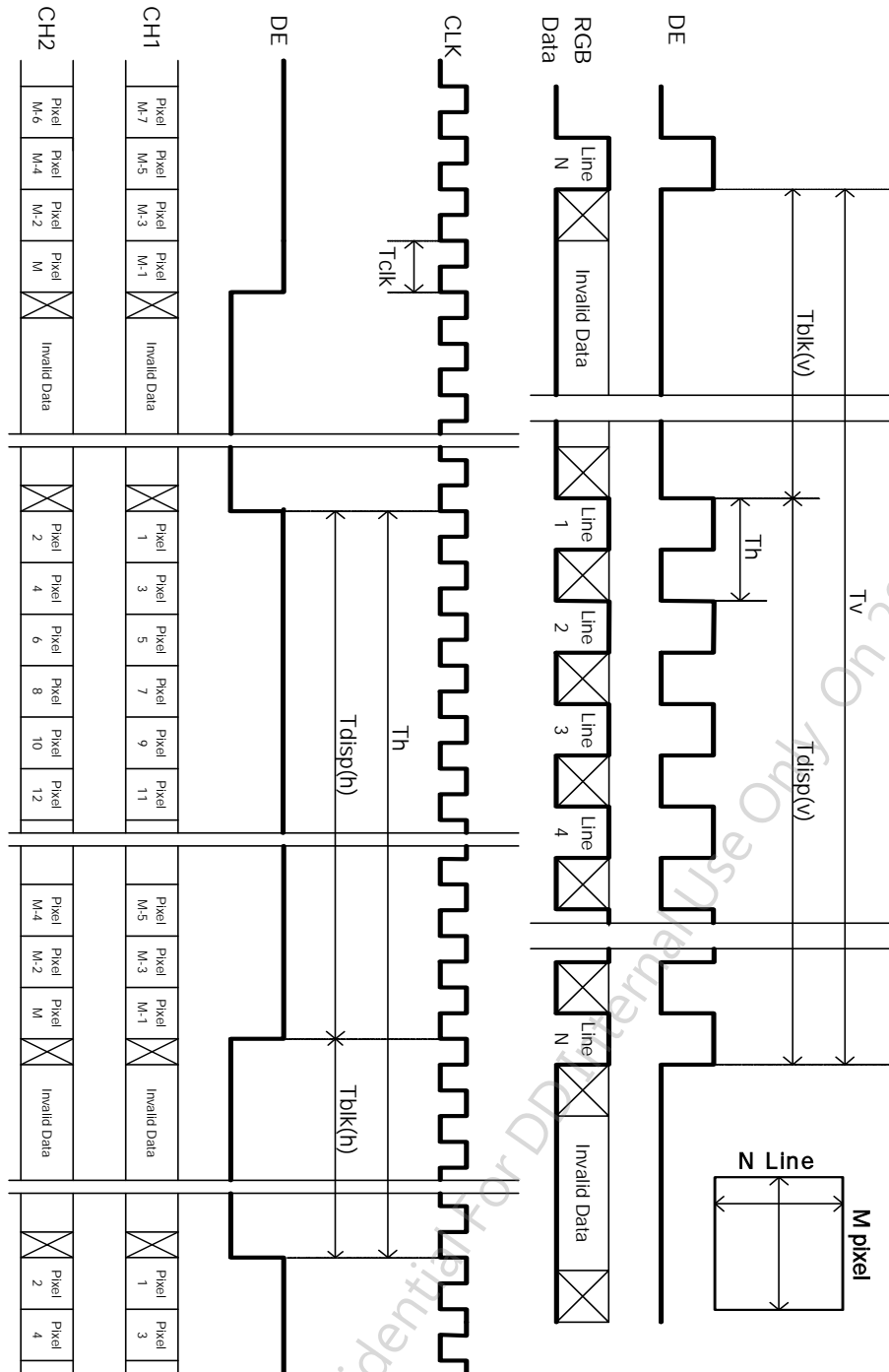

3.5. Color Input Data Reference

The brightness of each primary color (red, green and blue) is based on the 8 and 10 bits gray scale data input for the color; the higher the binary input, the brighter the color. The table below provides a reference for color versus data input.

8 Bits COLOR DATA REFERENCE

Color		Input Color Data																							
		RED								GREEN								BLUE							
		MSB				LSB				MSB				LSB				MSB				LSB			
		R7	R6	R5	R4	R3	R2	R1	R0	G7	G6	G5	G4	G3	G2	G1	G0	B7	B6	B5	B4	B3	B2	B1	B0
Basic Color	Black	0	0	0	0	0	0	0	0	0	0	0	0	0	0	0	0	0	0	0	0	0	0	0	0
	Red(255)	1	1	1	1	1	1	1	1	0	0	0	0	0	0	0	0	0	0	0	0	0	0	0	0
	Green(255)	0	0	0	0	0	0	0	0	1	1	1	1	1	1	1	1	0	0	0	0	0	0	0	0
	Blue(255)	0	0	0	0	0	0	0	0	0	0	0	0	0	0	0	0	1	1	1	1	1	1	1	1
	Cyan	0	0	0	0	0	0	0	0	1	1	1	1	1	1	1	1	1	1	1	1	1	1	1	1
	Magenta	1	1	1	1	1	1	1	1	0	0	0	0	0	0	0	0	1	1	1	1	1	1	1	1
	Yellow	1	1	1	1	1	1	1	1	1	1	1	1	1	1	1	1	0	0	0	0	0	0	0	0
	White	1	1	1	1	1	1	1	1	1	1	1	1	1	1	1	1	1	1	1	1	1	1	1	1
R	RED(000)	0	0	0	0	0	0	0	0	0	0	0	0	0	0	0	0	0	0	0	0	0	0	0	0
	RED(001)	0	0	0	0	0	0	0	1	0	0	0	0	0	0	0	0	0	0	0	0	0	0	0	0

	RED(254)	1	1	1	1	1	1	1	0	0	0	0	0	0	0	0	0	0	0	0	0	0	0	0	0
	RED(255)	1	1	1	1	1	1	1	1	0	0	0	0	0	0	0	0	0	0	0	0	0	0	0	0
G	GREEN(000)	0	0	0	0	0	0	0	0	0	0	0	0	0	0	0	0	0	0	0	0	0	0	0	0
	GREEN(001)	0	0	0	0	0	0	0	0	0	0	0	0	0	0	1	0	0	0	0	0	0	0	0	0

	GREEN(254)	0	0	0	0	0	0	0	0	1	1	1	1	1	1	1	0	0	0	0	0	0	0	0	0
	GREEN(255)	0	0	0	0	0	0	0	0	1	1	1	1	1	1	1	1	0	0	0	0	0	0	0	0
B	BLUE(000)	0	0	0	0	0	0	0	0	0	0	0	0	0	0	0	0	0	0	0	0	0	0	0	0
	BLUE(001)	0	0	0	0	0	0	0	0	0	0	0	0	0	0	0	0	0	0	0	0	0	0	0	1

	BLUE(254)	0	0	0	0	0	0	0	0	0	0	0	0	0	0	0	0	1	1	1	1	1	1	1	0
	BLUE(255)	0	0	0	0	0	0	0	0	0	0	0	0	0	0	0	0	1	1	1	1	1	1	1	1

10 Bits COLOR DATA REFERENCE

Color		Input Color Data																													
		RED										GREEN										BLUE									
		MSB					LSB					MSB					LSB					MSB					LSB				
		R9	R8	R7	R6	R5	R4	R3	R2	R1	R0	G9	G8	G7	G6	G5	G4	G3	G2	G1	G0	B9	B8	B7	B6	B5	B4	B3	B2	B1	B0
Basic Color	Black	0	0	0	0	0	0	0	0	0	0	0	0	0	0	0	0	0	0	0	0	0	0	0	0	0	0	0	0	0	0
	Red(1023)	1	1	1	1	1	1	1	1	1	1	0	0	0	0	0	0	0	0	0	0	0	0	0	0	0	0	0	0	0	0
	Green(1023)	0	0	0	0	0	0	0	0	0	0	1	1	1	1	1	1	1	1	1	1	0	0	0	0	0	0	0	0	0	0
	Blue(1023)	0	0	0	0	0	0	0	0	0	0	0	0	0	0	0	0	0	0	0	0	1	1	1	1	1	1	1	1	1	1
	Cyan	0	0	0	0	0	0	0	0	0	0	1	1	1	1	1	1	1	1	1	1	1	1	1	1	1	1	1	1	1	1
	Magenta	1	1	1	1	1	1	1	1	1	1	0	0	0	0	0	0	0	0	0	0	1	1	1	1	1	1	1	1	1	1
	Yellow	1	1	1	1	1	1	1	1	1	1	1	1	1	1	1	1	1	1	1	1	0	0	0	0	0	0	0	0	0	0
	White	1	1	1	1	1	1	1	1	1	1	1	1	1	1	1	1	1	1	1	1	1	1	1	1	1	1	1	1	1	1
R	RED(000)	0	0	0	0	0	0	0	0	0	0	0	0	0	0	0	0	0	0	0	0	0	0	0	0	0	0	0	0	0	
	RED(001)	0	0	0	0	0	0	0	0	1	0	0	0	0	0	0	0	0	0	0	0	0	0	0	0	0	0	0	0	0	

	RED(1022)	1	1	1	1	1	1	1	1	1	0	0	0	0	0	0	0	0	0	0	0	0	0	0	0	0	0	0	0	0	
	RED(1023)	1	1	1	1	1	1	1	1	1	0	0	0	0	0	0	0	0	0	0	0	0	0	0	0	0	0	0	0	0	
G	GREEN(000)	0	0	0	0	0	0	0	0	0	0	0	0	0	0	0	0	0	0	0	0	0	0	0	0	0	0	0	0	0	
	GREEN(001)	0	0	0	0	0	0	0	0	0	0	0	0	0	0	0	0	0	0	1	0	0	0	0	0	0	0	0	0	0	

	GREEN(1022)	0	0	0	0	0	0	0	0	0	1	1	1	1	1	1	1	1	1	1	0	0	0	0	0	0	0	0	0	0	
	GREEN(1023)	0	0	0	0	0	0	0	0	0	1	1	1	1	1	1	1	1	1	1	0	0	0	0	0	0	0	0	0	0	
B	BLUE(000)	0	0	0	0	0	0	0	0	0	0	0	0	0	0	0	0	0	0	0	0	0	0	0	0	0	0	0	0	0	
	BLUE(001)	0	0	0	0	0	0	0	0	0	0	0	0	0	0	0	0	0	0	0	0	0	0	0	0	0	0	0	0	1	

	BLUE(1022)	0	0	0	0	0	0	0	0	0	0	0	0	0	0	0	0	0	0	0	1	1	1	1	1	1	1	1	1	0	
	BLUE(1023)	0	0	0	0	0	0	0	0	0	0	0	0	0	0	0	0	0	0	0	1	1	1	1	1	1	1	1	1	1	

3.6. Power Sequence for LCD

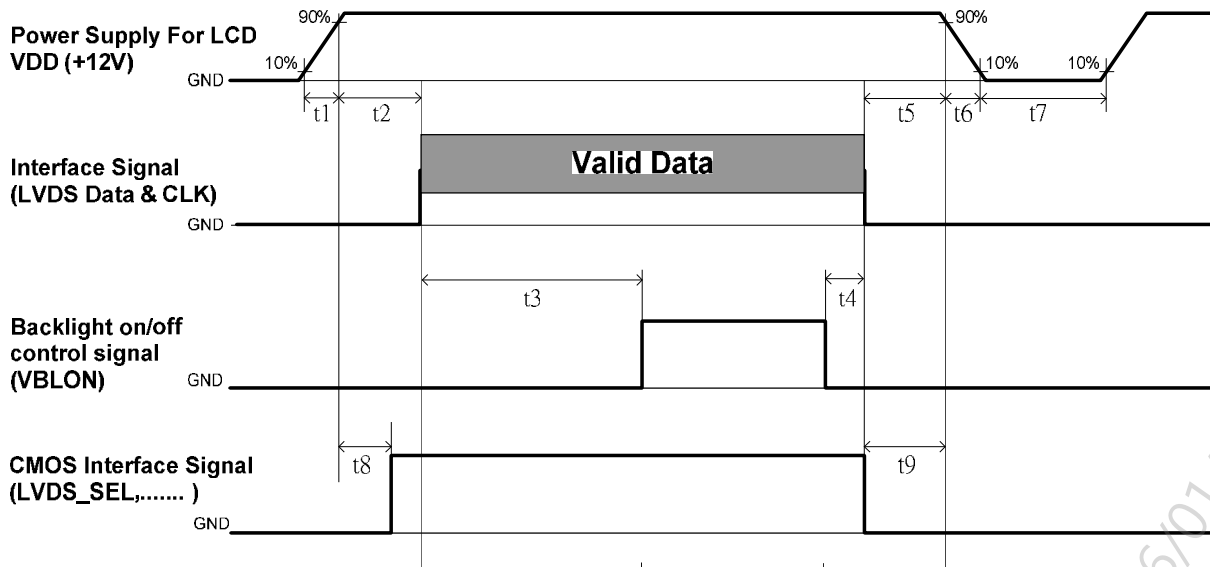

Parameter	Values			Unit
	Min.	Type.	Max.	
t1	0.4	---	30	ms
t2	0.1	---	50	ms
t3	450	---	---	ms
t4	0*1	---	---	ms
t5	0	---	---	ms
t6	---	---	---*2	ms
t7	500	---	---	ms
t8	20*3	---	50	ms
t9	0	---	---	ms

Note:

- (1) t4=0 : concern for residual pattern before BLU turn off.
- (2) t6 : voltage of VDD must decay smoothly after power-off. (customer system decide this value)
- (3) When CMOS Interface signal is N.C. (no connection), opened in Transmitted end, t8 timing spec can be negligible.

3.7. Backlight Specification

3.7.1. Electrical specification ($T_a = 25 \pm 2 \text{ }^\circ\text{C}$)

	Item	Symbol	Condition	Spec			Unit	Note	
				Min	Typ	Max			
1	Input Voltage	V _{DDB}	-	22.8	24	25.2	VDC	-	
2	Input Current	I _{DDB}	V _{DDB} =24V		3.2	3.7	ADC	1	
3	Input Power	P _{DDB}	V _{DDB} =24V		76.8	93.24	W	1	
4	Inrush Current	I _{RUSH}	V _{DDB} =24V			4.51	ADC	2	
5	On/Off control voltage	V _{B_{LON}}	ON	2 0	3.3	5.5	5.5	VDC	-
			OFF		0.8	0.8			0.8
6	On/Off control current	I _{B_{LON}}	V _{DDB} =24V	-	-	1.5	mA	-	
7	External PWM Control Voltage	V _{EPWM}	MAX	2	-	5.5	5.5	VDC	-
			MIN	0	-	0.8			0.8
8	External PWM Control Current	I _{EPWM}	V _{DDB} =24V	-	-	2	mADC	-	
9	External PWM Duty ratio	D _{EPWM}	V _{DDB} =24V	5	-	100	%	3	
10	External PWM Frequency	F _{EPWM}	V _{DDB} =24V	90	180	240	Hz	-	
11	DET status signal	DET	HI	Open Collector -	Open Collector			VDC	4
			Lo		0.8	0.8	0.8	VDC	4
12	Input Impedance	R _{in}	V _{DDB} =24V	300			Kohm	-	

Note 1 : Dimming ratio= 100% (MAX) ($T_a=25\pm 5^\circ\text{C}$, Turn on for 45minutes)

Note 2: Measurement condition Rising time = 20ms (V_{DDB} : 10%~90%);

Note 3: Less than 5% dimming control is functional well and no backlight shutdown happened

Note 4: Normal: 0~0.8V; Abnormal: Open collector

3.7.2. Input Pin Assignment

LED driver board connector : Cvilux CI0114M1HR0-NH

Pin	Symbol	Description
1	VDDB	Operating Voltage Supply, +24V DC regulated
2	VDDB	Operating Voltage Supply, +24V DC regulated
3	VDDB	Operating Voltage Supply, +24V DC regulated
4	VDDB	Operating Voltage Supply, +24V DC regulated
5	VDDB	Operating Voltage Supply, +24V DC regulated
6	BLGND	Ground and Current Return
7	BLGND	Ground and Current Return
8	BLGND	Ground and Current Return
9	BLGND	Ground and Current Return
10	BLGND	Ground and Current Return
11	DET	BLU status detection: Normal : 0~0.8V ; Abnormal : Open collector (Recommend Pull high R > 10K, VDD = 3.3V)
12	VBLON	BLU On-Off control: High/Open (2~5.5V) : BL On ; Low (0~0.8V/GND) : BL Off
13	NC	NC
14	PDIM(*)	External PWM (5%~100% Duty, open for 100%)

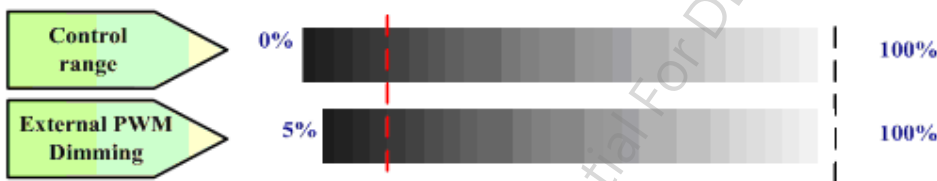

PWM Dimming : include Internal and External PWM Dimming

(Note*) IF External PWM function includes 5% dimming ratio. Judge condition as below:

- (1) Backlight module must be lighted ON normally.
- (2) All protection function must work normally.

Uniformity and flicker could NOT be guaranteed

3.7.3. Power Sequence for Backlight

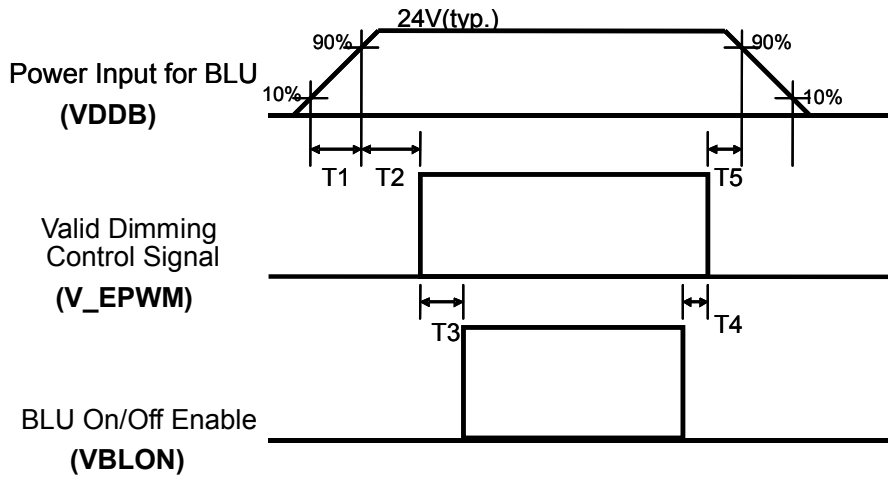

Dip condition

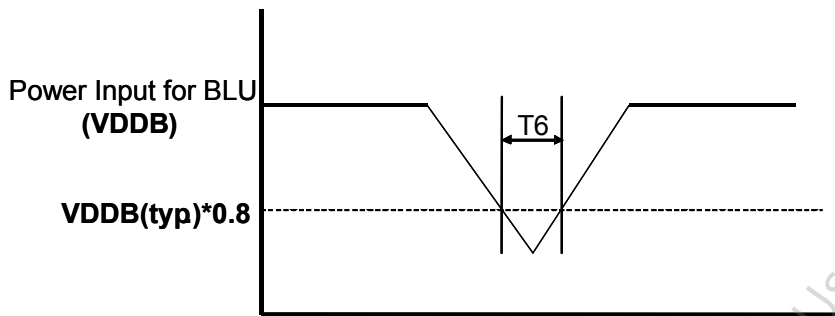

Parameter	Value			Units
	Min	Typ	Max	
T1	20	-	-	ms
T2	250	-	-	ms
T3	200	-	-	ms
T4	0	-	-	ms
T5	0	-	-	ms
T6	-	-	1000	ms ^{*1}

Note:1. T6 describes VDDB dip condition and VDDB couldn't lower than 10% VDDB.

3.7.4. LED Operating Life Time

Parameter	Symbol	Value			Unit	Note
		Min.	Typ.	Max		
Backlight Operating Life Time(MTTF)		50000	60000		Hour	1

Note:

- The lifetime (MTTF) is defined as the time which luminance of LED is 50% compared to its original value.
[Operating condition: Continuous operating at $T_a = 25 \pm 2$, for single lamp/LED only]

AUO Confidential For DD Internal Use Only On 2016/01/14

4. Reliability Test Items

	Test Item	Q'ty	Condition
1	High temperature storage test	3	60□, 500hrs
2	Low temperature storage test	3	-20□, 500hrs
3	High temperature operation test	3	50□, 500hrs
4	Low temperature operation test	3	-5□, 500hrs
5	Vibration test (non-operation)	3	Wave form: random Vibration level : 1.0G RMS Bandwidth : 10-300Hz Duration : X axis, Vertical, 10min Y axis, Vertical, 10min Z axis, Vertical, 10min one time each direction
6	Shock test (non-operation)	3	Shock level 50G ,20ms ±X,Y,Z axis Waveform: half sine wave Direction: One time each direction
7	Vibration test (With carton)	1CTN/7PCS	Random wave (1.04Grms 2~200Hz) Duration : X,Y,Z 20min per axes
8	Drop test (With carton)	1CTN/7PCS	Height: 30.5 cm (ASTMD4169-I) Sequence:1 corner, 3 edges, 6 surfaces (refer ASTM D 5276)

5. International Standard

5.1. Safety

- (1) **UL 60950-1; Standard for Safety of Information Technology Equipment Including electrical Business Equipment.**
- (2) **IEC 60950-1; Standard for Safety of International Electrotechnical Commission**
- (3) **EN 60950-1; European Committee for Electrotechnical Standardization (CENELEC), EUROPEAN STANDARD for Safety of Information Technology Equipment Including Electrical Business Equipment.**

5.2. EMC

- (1) **ANSI C63.4 “Methods of Measurement of Radio-Noise Emissions from Low-Voltage Electrical and Electrical Equipment in the Range of 9kHz to 40GHz. “American National standards Institute(ANSI), 1992**
- (2) **C.I.S.P.R “Limits and Methods of Measurement of Radio Interface Characteristics of Information Technology Equipment.” International Special committee on Radio Interference.**
- (3) **EN 55022 “Limits and Methods of Measurement of Radio Interface Characteristics of Information Technology Equipment.” European Committee for Electrotechnical Standardization. (CENELEC), 1998**



6. Packing

6.1. Definition of Label

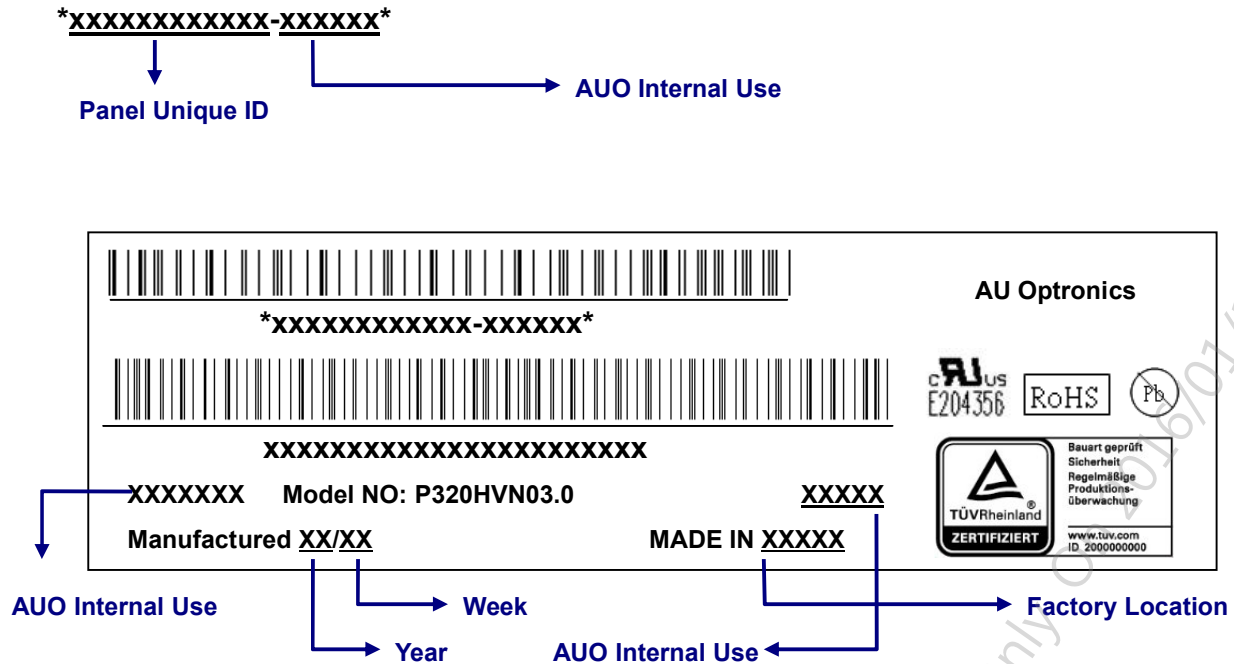
A. Panel Label:



Green mark description

- (1) For Pb Free Product, AUO will add  for identification.
- (2) For RoHs compatible products, AUO will add  for identification.

Note: The green Mark will be present only when the green documents have been ready by AUO internal green team. (definition of green design follows the AUO green design checklist.)

B. Carton Label:

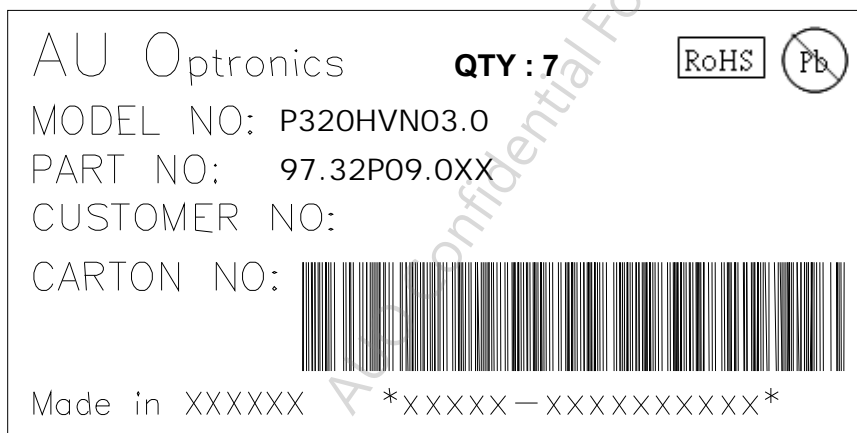

6.2. Packing Methods

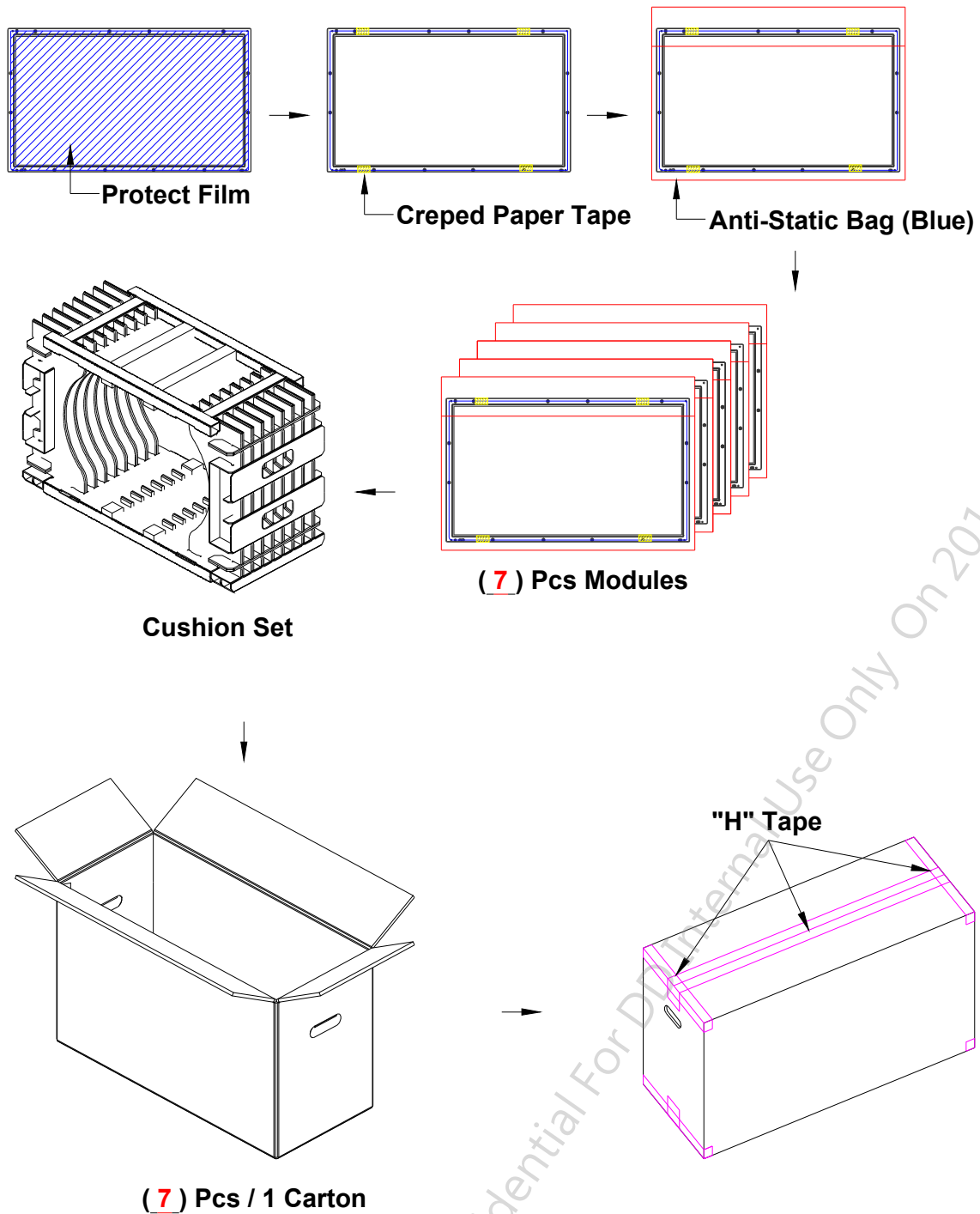

AUO Confidential For DD Internal Use Only On 2016/01/14

6.3. Pallet and Shipment Information

	Item	Specification			Packing Remark
		Qty.	Dimension	Weight (kg)	
1	Packing Box	7pcs/box	820(L)*376(W)*535(H)	39.47	
2	Pallet	1	1150(L)*840(W)*132(H)	15.6	
3	Boxes per Pallet	6 boxes/pallet			
4	Panels per Pallet	42 boxes/pallet			
5	Pallet after packing	42	1150(L)*840(W)*1202(H)	252.42	

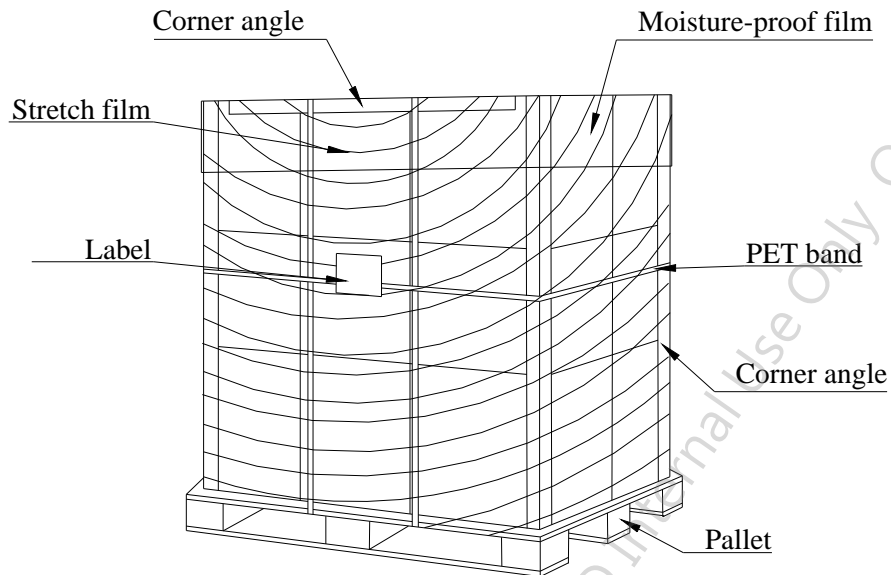

7. Precautions

Please pay attention to the followings when you use this TFT LCD module.

7.1. Mounting Precautions

- (1) You must mount a module using holes arranged in four corners or four sides.
- (2) You should consider the mounting structure so that uneven force (ex. twisted stress) is not applied to module. And the case on which a module is mounted should have sufficient strength so that external force is not transmitted directly to the module.
- (3) Please attach the surface transparent protective plate to the surface in order to protect the polarizer. Transparent protective plate should have sufficient strength in order to resist external force.
- (4) You should adopt radiation structure to satisfy the temperature specification.
- (5) Acetic acid type and chlorine type materials for the cover case are not desirable because the former generates corrosive gas of attacking the polarizer at high temperature and the latter cause circuit broken by electro-chemical reaction.
- (6) Do not touch, push or rub the exposed polarizer with glass, tweezers or anything harder than HB pencil lead. And please do not rub with dust clothes with chemical treatment. Do not touch the surface of polarizer for bare hand or greasy cloth. (Some cosmetics are detrimental to the polarizer.)
- (7) When the surface becomes dusty, please wipe gently with absorbent cotton or other soft materials like chamois soaks with petroleum benzene. Normal-hexane is recommended for cleaning the adhesives used to attach front/ rear polarizer. Do not use acetone, toluene and alcohol because they cause chemical damage to the polarizer.
- (8) Wipe off saliva or water drops as soon as possible. Their long time contact with polarizer causes deformations and color fading.
- (9) Do not open the case because inside circuits do not have sufficient strength.

7.2. Operating Precautions

- (1) The spike noise causes the mis-operation of circuits. It should be lower than following voltage:
 $V = \pm 200\text{mV}$ (Over and under shoot voltage)
- (2) Response time depends on the temperature. (In lower temperature, it becomes longer..)
- (3) Brightness depends on the temperature. (In lower temperature, it may become lower.) And in lower temperature, response time (required time that brightness is stable after turned on) becomes longer.
- (4) Be careful for condensation at sudden temperature change. Condensation makes damage to polarizer or electrical contacted parts. And after fading condensation, smear or spot will occur.
- (5) When fixed patterns are displayed for a long time, remnant image is likely to occur.
- (6) Module has high frequency circuits. Sufficient suppression to the electromagnetic interference shall be done by system manufacturers. Grounding and shielding methods may

be important to minimize the interface.

7.3. Operating Condition for Public Information Display

The device listed in the product specification is designed and manufactured for PID (Public Information Display) application. To optimize module's lifetime and function, below operating usages are required.

(1) Normal operating condition

- A. Operating temperature: 0~40
- B. Operating humidity: 10~90%
- C. Display pattern: dynamic pattern (Real display).

Note) Long-term static display would cause image sticking.

(2) Operation usage to protect against image sticking due to long-term static display.

- A. Suitable operating time: 20 hours a day or less.
(* The moving picture can be allowed for 24 hours a day)
- B. Liquid Crystal refresh time is required. Cycling display between 5 minutes' information (static) display and 10 seconds' moving image.
- C. Periodically change background and character (image) color.
- D. Avoid combination of background and character with large different luminance.

(3) Periodically adopt one of the following actions after long time display.

- A. Running the screen saver (motion picture or black pattern)
- B. Power off the system for a while

(4) LCD system is required to place in well-ventilated environment. Adapting active cooling system is highly recommended.

(5) Product reliability and functions are only guaranteed when the product is used under right operation usages. If product will be used in extreme conditions, such as high temperature/humidity, display stationary patterns, or long operation time etc..., it is strongly recommended to contact AUO for filed application engineering advice. Otherwise, its reliability and function may not be guaranteed. Extreme conditions are commonly found at airports, transit stations, banks, stock market and controlling systems.

7.4. Electrostatic Discharge Control

Since a module is composed of electronic circuits, it is not strong to electrostatic discharge. Make certain that treatment persons are connected to ground through wristband etc. And don't touch interface pin directly.

7.5. Precautions for Strong Light Exposure

Strong light exposure causes degradation of polarizer and color filter.

7.6. Storage

When storing modules as spares for a long time, the following precautions are necessary.

- (1) Store them in a dark place. Do not expose the module to sunlight or fluorescent light. Keep the temperature between 5° and 35° at normal humidity.
- (2) The polarizer surface should not come in contact with any other object. It is recommended that they be stored in the container in which they were shipped.
- (3) Storage condition is guaranteed under packing conditions.
- (4) The phase transition of Liquid Crystal in the condition of the low or high storage temperature will be recovered when the LCD module returns to the normal condition.

7.7. Handling Precautions for Protection Film

- (1) The protection film is attached to the bezel with a small masking tape. When the protection film is peeled off, static electricity is generated between the film and polarizer. This should be peeled off slowly and carefully by people who are electrically grounded and with well ion-blown equipment or in such a condition, etc.
- (2) When the module with protection film attached is stored for a long time, sometimes there remains a very small amount of glue still on the bezel after the protection film is peeled off.
- (3) You can remove the glue easily. When the glue remains on the bezel or its vestige is recognized, please wipe them off with absorbent cotton waste or other soft material like chamois soaked with normal-hexane.

Our company network supports you worldwide with offices in Germany, Austria, Switzerland, the UK and the USA. For more information please contact:

Headquarters

Germany



FORTEC Elektronik AG

Lechwiesenstr. 9
86899 Landsberg am Lech

Phone: +49 8191 91172-0
E-Mail: sales@forteca.de
Internet: www.forteca.de

Fortec Group Members

Austria



FORTEC Elektronik AG

Office Vienna

Nuschinggasse 12
1230 Wien

Phone: +43 1 8673492-0
E-Mail: office@fortec.at
Internet: www.fortec.at

Germany



Distec GmbH

Augsburger Str. 2b
82110 Germering

Phone: +49 89 894363-0
E-Mail: info@distec.de
Internet: www.distec.de

Switzerland



ALTRAC AG

Bahnhofstraße 3
5436 Würenlos

Phone: +41 44 7446111
E-Mail: info@altrac.ch
Internet: www.altrac.ch

United Kingdom



Display Technology Ltd.

Osprey House, 1 Osprey Court
Hichingbrooke Business Park
Huntingdon, Cambridgeshire, PE29 6FN

Phone: +44 1480 411600
E-Mail: info@displaytechnology.co.uk
Internet: www.displaytechnology.co.uk

USA



Apollo Display Technologies, Corp.

87 Raynor Avenue,
Unit 1 Ronkonkoma,
NY 11779

Phone: +1 631 5804360
E-Mail: info@apolloDisplays.com
Internet: www.apolloDisplays.com