



OUR GLOBAL
COMPETENCE
CENTRES

 APOLLO DISPLAY
TECHNOLOGIES



 DISTEC



 DISPLAY
TECHNOLOGY



Datasheet

SGD

GBHE') GN; 7%\$

SG-01-0€

Product Specification



	Model: GNTQ35SNGC1E0	Rev. No.	Issued Date.	Page.
		B	2017.Jan.23	1 / 20

**Thin-Film-Transistor LCD Module
Model: GNTQ35SNGC1E0**

Acceptance

Solomon Goldentek Display Corp.
NO. 18 Ta-Yeh St., Ta-Fa Industrial Park, Ta-Liao
Hsiang, Kaohsiung Hsien 831, TAIWAN , R.O.C.
FAX: 886-7-7886800

Approved and Checked by

Approved by	Checked by		Made by
			

Product Specification

	Model: GNTQ35SNGC1E0	Rev. No.	Issued Date.	Page.
		B	2017.Jan.23	2 / 20

Revise Records

Rev.	Date	Contents	Written	Approved
A	2016/06/24	Preliminary Specification	Kevin Huang	Roger Yang
B	2016/01/23	Modify: Top: 85°C → 80°C	Kevin Huang	Roger Yang

Special Notes

Note1.	
Note2.	
Note3.	
Note4.	
Note5.	

Product Specification				
	Model: GNTQ35SNGC1E0	Rev. No.	Issued Date.	Page.
		B	2017.Jan.23	3 / 20

Contents

1. General Description and Features	4
1.1 Features	4
1.2 LCD Module	4
2. Mechanical Information	5
3. Electrical Specifications	6
3.1 Absolute Max. Ratings	6
3.2 Electrical Absolute Rating	7
4 Electrical Characteristics	8
4.1 TFT-LCD Module (DC Characteristics)	8
4.2 Backlight Unit	9
5 Block Diagram	10
TFT-LCD Module with Backlight Unit	10
6 Input Terminal Pin Assignment	11
6.1 Pin Assignment (LCD)	11
7 Optical Characteristics	13
8 Basic Display Color and Gray Scale	16
9 Interface Timing	17
9.1 Input Signal Characteristics	17
9.2 Waveform	18
9.3 Power On/Off Sequence	18
10 Reliability Condition for LCD	19
11 Dimensional outlines	20

Product Specification

	Model: GNTQ35SNGC1E0	Rev. No.	Issued Date.	Page.
		B	2017.Jan.23	4 / 20

1. General Description and Features

GNTQ35SNGC1E0 is a TM (Transmissive) type color active matrix TFT (Thin Film Transistor) liquid crystal display (LCD) that uses amorphous silicon TFT as a switching device. This model is composed of a TFT-LCD module, a driver circuit and a back-light unit . The resolution of a 3.5" contains 320RGBx240 dots and can display up to 16.7M colors. The following table described the features of GNTQ35SNGC1E0.

1.1 Features

- QVGA(320 x 240 pixels) resolution.
- Display in 16.7M colors.
- On-chip voltage generator.
- SYNC mode is supported for digital RGB input data format.

1.2 LCD Module

Item	Specification	Unit
Screen Size	3.5 inches	Diagonal
Display Resolution	320 x RGB x 240	Dot
Dot Pitch	0.073 (H) x 0.219 (V)	mm
Active Area	70.08 (H) x 52.56 (V)	mm
Outline Dimension	76.9 (W) x 63.9 (H) x 3.15 (D)	mm
Display Mode	Normally white/Transmissive	--
Pixel Arrangement	RGB-Stripe	--
Surface Treatment	Anti-glare(AG)	--
Display Color	16.7M	--
Viewing Direction	6 o'clock (Gray Inversion)	--
Input Interface	Digital 8-bits color RGB	--
Color Gamut	NTSC 60%	--

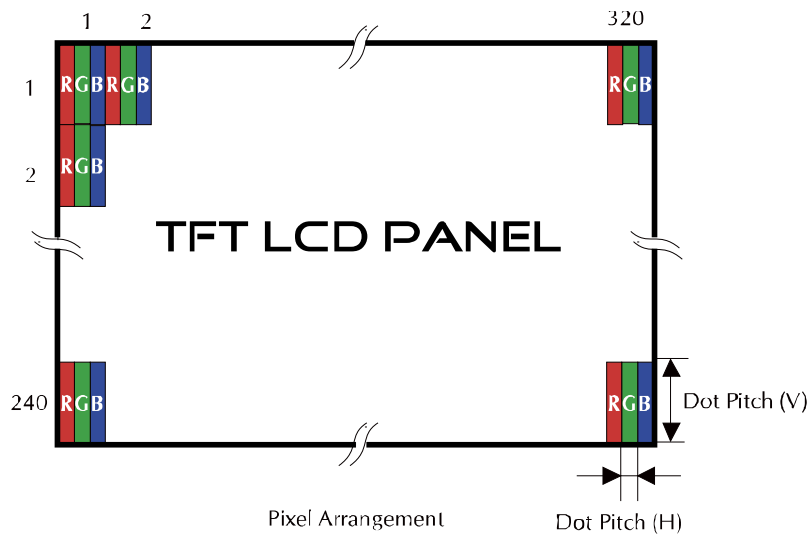

Product Specification

	Model: GNTQ35SNGC1E0	Rev. No.	Issued Date.	Page.
		B	2017.Jan.23	5 / 20

2. Mechanical Information

Item	Min.	Typ.	Max.	Unit	Note	
Module Size	Horizontal (H)	--	76.90	--	mm	--
	Vertical (V)	--	63.90	--	mm	(1)
	Thickness (T)	--	3.15	--	mm	(2)
Weight	--	32	37	g	--	

Note (1) Not include FPC.

Refer to the Outline Dimension for further information.

Product Specification

	Model: GNTQ35SNGC1E0	Rev. No.	Issued Date.	Page.
		B	2017.Jan.23	6 / 20

3. Electrical Specifications

3.1 Absolute Max. Ratings

3.1.1 Absolute Ratings of Environment

If the operating condition exceeds the following absolute maximum ratings, the TFT LCD module may be damaged permanently.

($T_a=25\pm 2^{\circ}\text{C}$, $V_{SS}=\text{GND}=0$)

Item	Symbol	Min.	Max.	Unit	Note
Storage temperature	T_{STG}	-40	90	$^{\circ}\text{C}$	(1)
Operating temperature	T_{OPR}	-30	80	$^{\circ}\text{C}$	(1,2,3)

Note (1) 95 % RH Max. ($40^{\circ}\text{C} \geq T_a$). Maximum wet-bulb temperature at 39°C or less. ($T_a > 40^{\circ}\text{C}$)
No condensation.

Note (2) In case of below 0° , the response time of liquid crystal (LC) becomes slower and the color of panel becomes darker than normal one. Level of retardation depends on temperature, because of LC's character

Note (3) Only operation is guaranteed at operating temperature. Contrast, response time, another display quality are evaluated at $+25^{\circ}\text{C}$.

Product Specification

	Model: GNTQ35SNGC1E0	Rev. No.	Issued Date.	Page.
		B	2017.Jan.23	7 / 20

3.2 Electrical Absolute Rating

3.2.1 TFT-LCD Module

(Voltage Referenced to VSS)

Item	Symbol	Value		Unit	Condition
		Min.	Max.		
Digital Power Supply Voltage	Vcc	VSS-0.3	5.0	V	--

3.2.2 Back-Light Unit

(Ta=25±2°C)

Item	Symbol	Min.	Max.	Unit	Note
Forward current	I _f	--	(30)	mA	(1)
Reverse voltage	V _R	--	(30)	V	(1)

Note (1) Permanent damage to the device may occur if maximum values are exceeded or reverse voltage is loaded. Functional operation should be restricted to the conditions described under normal operating conditions.

Product Specification

	Model: GNTQ35SNGC1E0	Rev. No.	Issued Date.	Page.
		B	2017.Jan.23	8 / 20

4 Electrical Characteristics

4.1 TFT-LCD Module (DC Characteristics)

Item	Symbol	Value			Unit	Note
		Min.	Typ.	Max.		
Digital Power Supply Voltage	V_{CC}	2.5	3.3	3.6	V	
Input High Threshold Voltage	V_{IH}	$0.8 V_{CC}$	-	V_{CC}	V	
Input Low Threshold Voltage	V_{IL}	0	-	$0.2 V_{CC}$	V	
Power Supply Current	I_{CC}	-	(15.6)	(22.0)	mA	(1)
Power Consumption	P_L	-	(51.48)	(72.6)	mW	(1)

Note (1) The specified power consumption is under the conditions at $V_{CC}=3.3V$, $F_V=60Hz$, whereas a Power dissipation check pattern below is displayed.

Black Pattern / 0 Gray

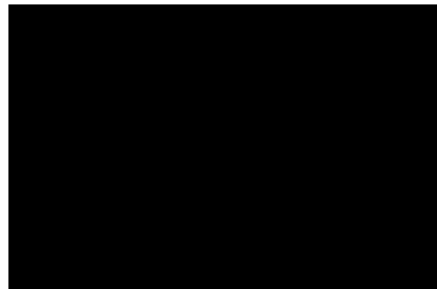

Active Area

Product Specification

	Model: GNTQ35SNGC1E0	Rev. No.	Issued Date.	Page.
		B	2017.Jan.23	9 / 20

4.2 Backlight Unit

The back-light system is an edge-lighting type with six white LEDs (Light Emitting Diode).

(Ta=25±2°C)

Item	Symbol	Value			Unit	Condition
		Min.	Typ.	Max.		
LED Voltage	VL	-	(17)	-	V	
LED Current	I _B	-	30	-	mA	
Power Consumption	P _{BL}	-	(510)	-	mW	
LED Life Time(25°C)	-	40000	-	-	hr	(2)

Note (1) Where I_B = 30mA, V_F = 17, P_{BL} = V_F × I_B

(2) The lifetime of LED is defined as the time when it continues to operate under the conditions at

T_a = 25 ± 2 °C and Duty 100% until the brightness becomes ≤ 50% of its original value.

Product Specification

	Model: GNTQ35SNGC1E0	Rev. No.	Issued Date.	Page.
		B	2017.Jan.23	10 / 20

5 Block Diagram

TFT-LCD Module with Backlight Unit

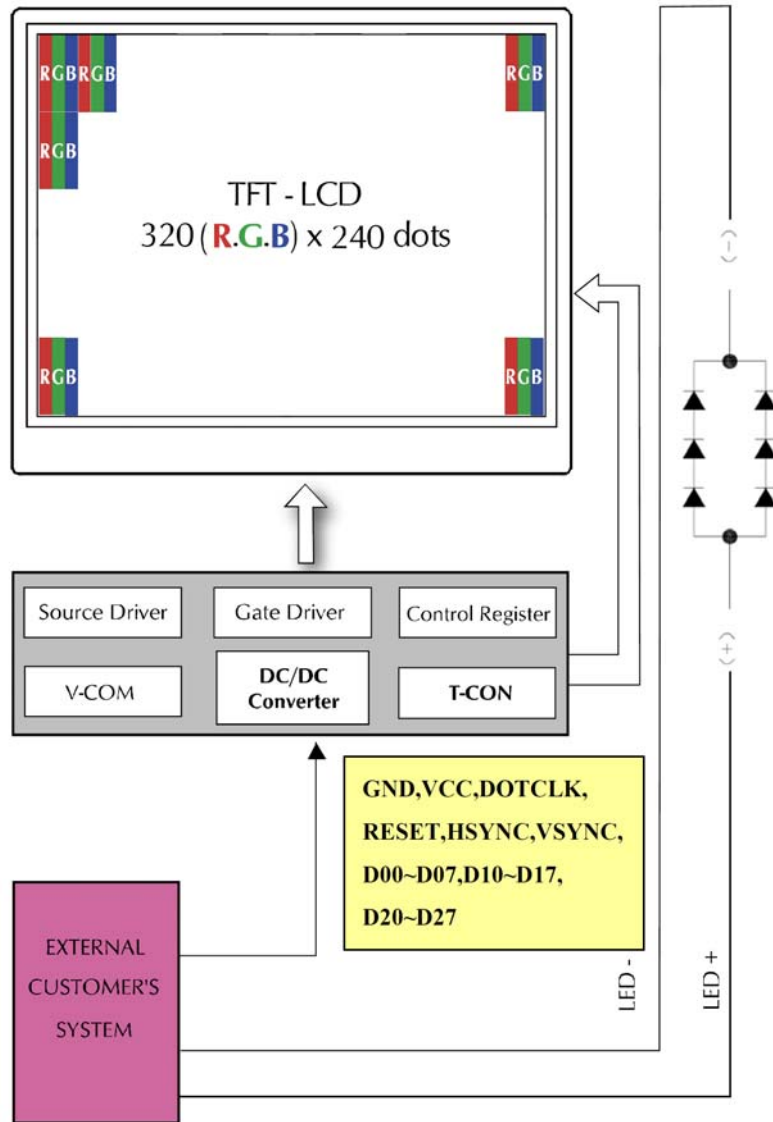

Product Specification

	Model: GNTQ35SNGC1E0	Rev. No.	Issued Date.	Page.
		B	2017.Jan.23	11 / 20

6 Input Terminal Pin Assignment

6.1 Pin Assignment (LCD)

Pin No.	Symbol	I/O	Function	Remark
1	LED_K	I	Backlight LED Ground	
2	LED_K	I	Backlight LED Ground	
3	LED_A	I	Backlight LED Power	
4	LED_A	I	Backlight LED Power	
5	N/C	I	Not Connection	
6	N/C	I	Not Connection	
7	N/C	I	Not Connection	
8	RESET	I	Hardware Reset	
9	NC	I	Not Connection	
10	NC	I	Not Connection	
11	NC	--	Not Connection	
12	B0	I	Blue Data (LSB)	
13	B1	I	Blue Data	
14	B2	I	Blue Data	
15	B3	I	Blue Data	
16	B4	I	Blue Data	
17	B5	I	Blue Data	
18	B6	I	Blue Data	
19	B7	I	Blue Data (MSB)	
20	G0	I	Green Data (LSB)	
21	G1	I	Green Data	
22	G2	I	Green Data	
23	G3	I	Green Data	
24	G4	I	Green Data	
25	G5	I	Green Data	
26	G6	I	Green Data	
27	G7	I	Green Data (MSB)	
28	R0	I	Red Data (LSB)	
29	R1	I	Red Data	
30	R2	I	Red Data	
31	R3	I	Red Data	
32	R4	I	Red Data	
33	R5	I	Red Data	

Product Specification

	Model: GNTQ35SNGC1E0	Rev. No.	Issued Date.	Page.
		B	2017.Jan.23	12 / 20

34	R6	I	Red Data	
35	R7	I	Red Data (MSB)	
36	H _{SYNC}	I	Horizontal Sync Input	
37	V _{SYNC}	I	Vertical Sync Input	
38	D _{OTCLK}	I	Dot Data Clock	
39	N/C	I	Not Connection	
40	N/C	I	Not Connection	
41	VCC	I	For system power supply.	
42	VCC	I	For system power supply.	
43	N/C	I	Not Connection	
44	N/C	I	Not Connection	
45	N/C	I	Not Connection	
46	N/C	I	Not Connection	
47	N/C	I	Not Connection	
48	N/C	I	Not Connection	
49	N/C	I	Not Connection	
50	N/C	I	Not Connection	
51	N/C	I	Not Connection	
52	N/C	I	Not Connection	
53	GND	I	Ground	
54	GND	I	Ground	

Product Specification

	Model: GNTQ35SNGC1E0	Rev. No.	Issued Date.	Page.
		B	2017.Jan.23	13 / 20

7 Optical Characteristics

The following items are measured under stable conditions. The optical characteristics should be measured in a dark room or equivalent state with the methods shown in Note (1).
 Measuring equipment: BM-5A, BM-7,

(Ta=25±2°C)

Item		Symbol	Condition	Min	Type	Max	Unit	Note	
Brightness		--	$\theta=0^\circ$ Normal Viewing Angle	900	1000	--	cd/m ²	--	
Response time		T _R		--	15	20	ms	--	
		T _F		--	35	50	ms		
Brightness uniformity		B _{UNI}			80	-	-	%	
Contrast ratio		CR			300	450	--	--	--
Color Chromaticity (CIE1931)		Red		x	0.554	0.604	0.654	--	--
				y	0.301	0.351	0.401		
		Green		x	0.285	0.335	0.385	--	
				y	0.546	0.596	0.646		
		Blue		x	0.085	0.135	0.185	--	
			y	0.034	0.084	0.134			
		White	x	0.272	0.322	0.372	--		
			y	0.306	0.356	0.406			
Viewing Angle (6H)		Hor.	θ_R	50	60	--	Degree	--	
			θ_L	50	60	--			
		Ver.	ϕ_H	40	50	--			
			ϕ_L	50	60	--			

Product Specification

	Model: GNTQ35SNGC1E0	Rev. No.	Issued Date.	Page.
		B	2017.Jan.23	14 / 20

a. Test equipment setup

After stabilizing and leaving the panel alone shall be warmed up for the stable operation of LCM, the measurement should be executed. Measurement should be executed in a stable, windless, and dark room. Optical specifications are measured by Topcon BM-7(fast) with a viewing angle of 2° at a distance of 50cm and normal direction.

b. Definition of response time: Tr and Tf

The response time is defined as the following figure and shall be measured by switching the input signal for "black" and "white".

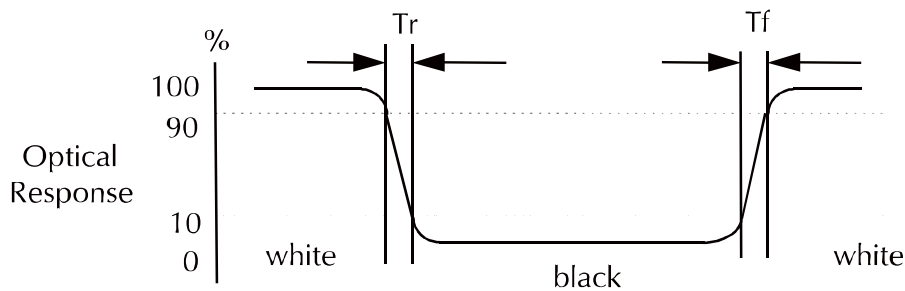

c. Definition of contrast ratio:

$$\text{Contrast Ratio (CR)} = \frac{\text{Brightness measured when LCD is at "white state"}}{\text{Brightness measured when LCD is at "black state"}}$$

d. Measured at the center area of the panel when all the input terminals of LCD panel are electrically opened.

Product Specification

	Model: GNTQ35SNGC1E0	Rev. No.	Issued Date.	Page.
		B	2017.Jan.23	15 / 20

e. View Angle

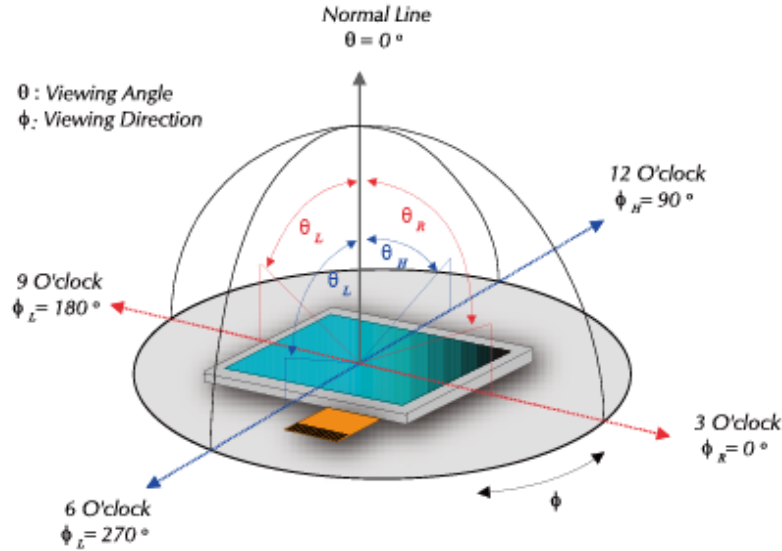

f. Definition of Luminance of White: Luminance of white at the center points

Light Source of Back-Light Unit	LED Type
---------------------------------	----------

g. Definition of White Uniformity

$$\text{White Uniformity} = \frac{\text{Min. luminance of white among 9-points}}{\text{Max. luminance of white among 9-points}}$$

h. The definition of Color Gamut -Color Chromaticity CIE 1931

Color coordinate of white & red, green, blue at center point.

Color Gamut : NTSC(%) = (RGB Triangle Area / NTSC Triangle Area) x 100

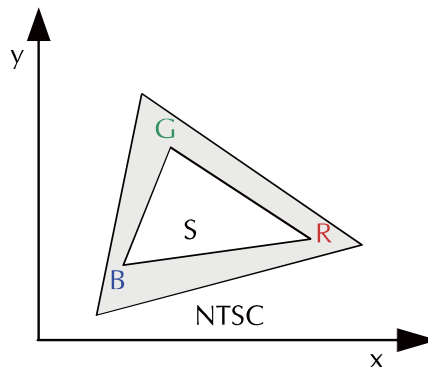

Product Specification

	Model: GNTQ35SNGC1E0	Rev. No.	Issued Date.	Page.
		B	2017.Jan.23	16 / 20

8 Basic Display Color and Gray Scale

	Color & Gray Scale	Data Signal																							
		D07	D06	D05	D04	D03	D02	D01	D00	D17	D16	D15	D14	D13	D12	D11	D10	D27	D26	D25	D24	D23	D22	D21	D20
Basic Color	Black	0	0	0	0	0	0	0	0	0	0	0	0	0	0	0	0	0	0	0	0	0	0	0	
	Red	1	1	1	1	1	1	1	1	0	0	0	0	0	0	0	0	0	0	0	0	0	0	0	
	Green	0	0	0	0	0	0	0	0	1	1	1	1	1	1	1	1	0	0	0	0	0	0	0	
	Blue	0	0	0	0	0	0	0	0	0	0	0	0	0	0	0	0	1	1	1	1	1	1	1	
	Cyan	0	0	0	0	0	0	0	0	1	1	1	1	1	1	1	1	1	1	1	1	1	1	1	
	Magenta	1	1	1	1	1	1	1	1	0	0	0	0	0	0	0	0	1	1	1	1	1	1	1	
	Yellow	1	1	1	1	1	1	1	1	1	1	1	1	1	1	1	1	0	0	0	0	0	0	0	
	White	1	1	1	1	1	1	1	1	1	1	1	1	1	1	1	1	1	1	1	1	1	1	1	
Red	Black	0	0	0	0	0	0	0	0	0	0	0	0	0	0	0	0	0	0	0	0	0	0		
	Red(1)	0	0	0	0	0	0	0	1	0	0	0	0	0	0	0	0	0	0	0	0	0	0		
	Red(2)	0	0	0	0	0	0	1	0	0	0	0	0	0	0	0	0	0	0	0	0	0	0		
	:	:	:	:	:	:	:	:	:	:	:	:	:	:	:	:	:	:	:	:	:	:	:	:	
	Red(127)	0	1	1	1	1	1	1	1	0	0	0	0	0	0	0	0	0	0	0	0	0	0		
	:	:	:	:	:	:	:	:	:	:	:	:	:	:	:	:	:	:	:	:	:	:	:	:	
	Red(254)	1	1	1	1	1	1	1	0	0	0	0	0	0	0	0	0	0	0	0	0	0	0		
	Red(255)	1	1	1	1	1	1	1	1	0	0	0	0	0	0	0	0	0	0	0	0	0	0		
Green	Black	0	0	0	0	0	0	0	0	0	0	0	0	0	0	0	0	0	0	0	0	0	0		
	Green(1)	0	0	0	0	0	0	0	0	0	0	0	0	0	0	0	1	0	0	0	0	0	0		
	Green(2)	0	0	0	0	0	0	0	0	0	0	0	0	0	0	1	0	0	0	0	0	0	0		
	:	:	:	:	:	:	:	:	:	:	:	:	:	:	:	:	:	:	:	:	:	:	:	:	
	Green(127)	0	0	0	0	0	0	0	0	0	1	1	1	1	1	1	1	0	0	0	0	0	0		
	:	:	:	:	:	:	:	:	:	:	:	:	:	:	:	:	:	:	:	:	:	:	:	:	
	Green(254)	0	0	0	0	0	0	0	0	1	1	1	1	1	1	1	0	0	0	0	0	0	0		
	Green(255)	0	0	0	0	0	0	0	0	1	1	1	1	1	1	1	1	0	0	0	0	0	0		
Blue	Black	0	0	0	0	0	0	0	0	0	0	0	0	0	0	0	0	0	0	0	0	0	0		
	Blue(1)	0	0	0	0	0	0	0	0	0	0	0	0	0	0	0	0	0	0	0	0	0	1		
	Blue(2)	0	0	0	0	0	0	0	0	0	0	0	0	0	0	0	0	0	0	0	0	0	1		
	:	:	:	:	:	:	:	:	:	:	:	:	:	:	:	:	:	:	:	:	:	:	:	:	
	Blue(127)	0	0	0	0	0	0	0	0	0	0	0	0	0	0	0	0	1	1	1	1	1	1		
	:	:	:	:	:	:	:	:	:	:	:	:	:	:	:	:	:	:	:	:	:	:	:	:	
	Blue(254)	0	0	0	0	0	0	0	0	0	0	0	0	0	0	0	1	1	1	1	1	1	0		
	Blue(255)	0	0	0	0	0	0	0	0	0	0	0	0	0	0	0	1	1	1	1	1	1	1		

0 : Low level voltage, 1 : High level voltage

Each basic color can be displayed in 256 gray scales from 8 bit data signals. With the combination of total 24 bit data signals, the 16,777,216-color display can be achieved on the screen.

Product Specification

	Model: GNTQ35SNGC1E0	Rev. No.	Issued Date.	Page.
		B	2017.Jan.23	17 / 20

9 Interface Timing

9.1 Input Signal Characteristics

9.2.1 Digital Parallel RGB Interface (320*240 resolution)

Item	Symbol	Min.	Typ.	Max.	Unit	
DOTCLK Frequency	fDOTCLK	-	6.5	10	MHz	
DOTCLK Period	tDOTCLK	100	154	-	ns	
Horizontal Frequency (Line)	fH	-	14.9	22.35	KHz	
Vertical Frequency (Refresh)	fV	-	60	90	Hz	
Horizontal Back Porch	tHBP	-	68	-	tDOTCLK	
Horizontal Front Porch	tHFP	-	20	-	tDOTCLK	
Horizontal Data Start Point	tHBP	-	68	-	tDOTCLK	
Horizontal Blanking Period	tHBP + tHFP	-	88	-	tDOTCLK	
Horizontal Display Area	HDISP	-	320	-	tDOTCLK	
Horizontal Cycle	Hcycle	-	408	450	tDOTCLK	
Vertical Back Porch	tVBP	-	18	-	Lines	
Vertical Front Porch	tVFP	-	4	-	Lines	
Vertical Data Start Point	tVBP	-	18	-	Lines	
Vertical Blanking Period	tVBP + tVFP	-	22	-	Lines	
Vertical Display Area	NTSC	VDISP	-	240	-	Lines
	PAL			280(PALM=0)		
				288(PALM=1)		
Vertical Cycle	NTSC	Vcycle	-	262	350	Lines
	PAL			313		

Product Specification



Model: GNTQ35SNGC1E0

Rev. No.

Issued Date.

Page.

B

2017.Jan.23

18 / 20

9.2 Waveform

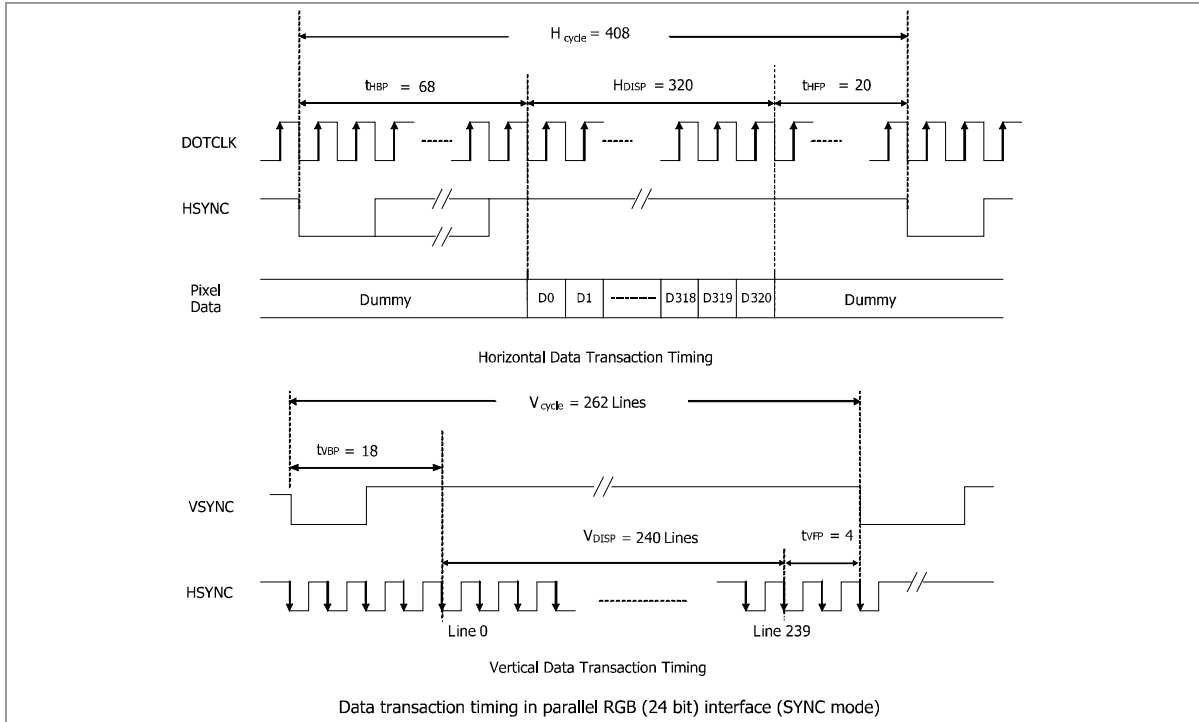

9.3 Power On/Off Sequence

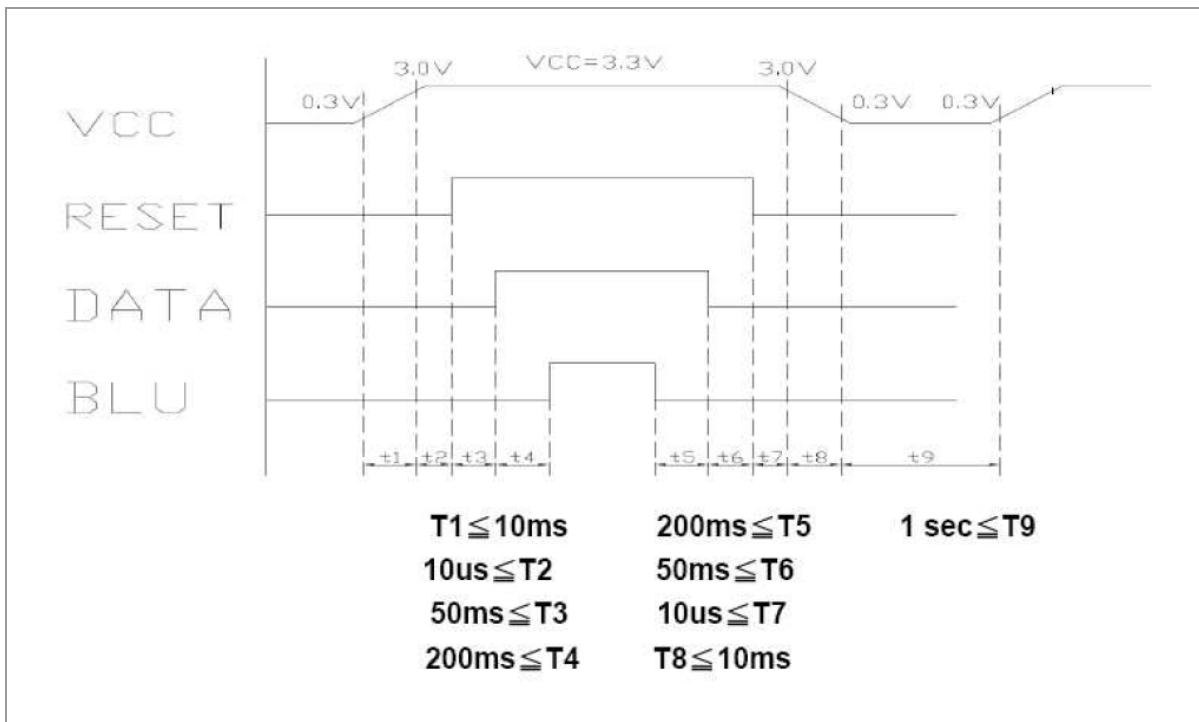

Product Specification

	Model: GNTQ35SNGC1E0	Rev. No.	Issued Date.	Page.
		B	2017.Jan.23	19 / 20

10 Reliability Condition for LCD

No change on display and in operation under the following test condition.

Condition: Unless otherwise specified, tests will be conducted under the following condition.

Temperature: 20±5°C Humidity: 65±5%RH

Tests will be not conducted under functioning state.

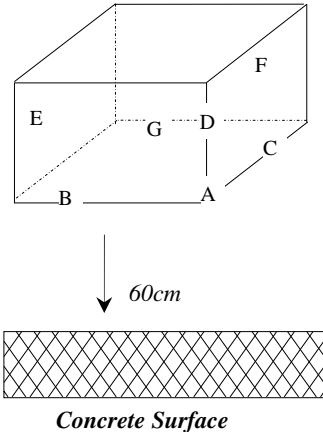
No.	Parameter	Condition	Notes
1	High Temperature Operating	80°C±2°C, 240hrs (Operation state)	--
2	Low Temperature Operating	-30°C±2°C, 240hrs (Operation state)	--
3	High Temperature Storage	90°C±2°C, 240hrs	--
4	Low Temperature Storage	-40°C±2°C, 240hrs	--
5	High Temperature and High Humidity Operation Test	60°C±2°C, 90%, 240hrs	--
6	Vibration Test	Total fixed amplitude: 1.5mm Vibration Frequency: 10~55Hz One cycle 60 seconds to 3 direction of X, Y, Z each 15 minutes.	--
7.	Drop Test	To be measured after dropping from 60cm high on the concrete surface in packing state. <div style="text-align: center; margin-top: 10px;">  </div> <div style="margin-left: 20px; margin-top: 10px;"> <i>Dropping method corner dropping</i> <i>A corner: once</i> <i>Edge dropping</i> <i>B, C, D edge: once</i> <i>Face dropping</i> <i>E, F, G face: once</i> </div>	--

Product Specification



Model: GNTQ35SNGC1E0

Rev. No.

Issued Date.

Page.

B

2017.Jan.23

20 / 20

11 Dimensional outlines

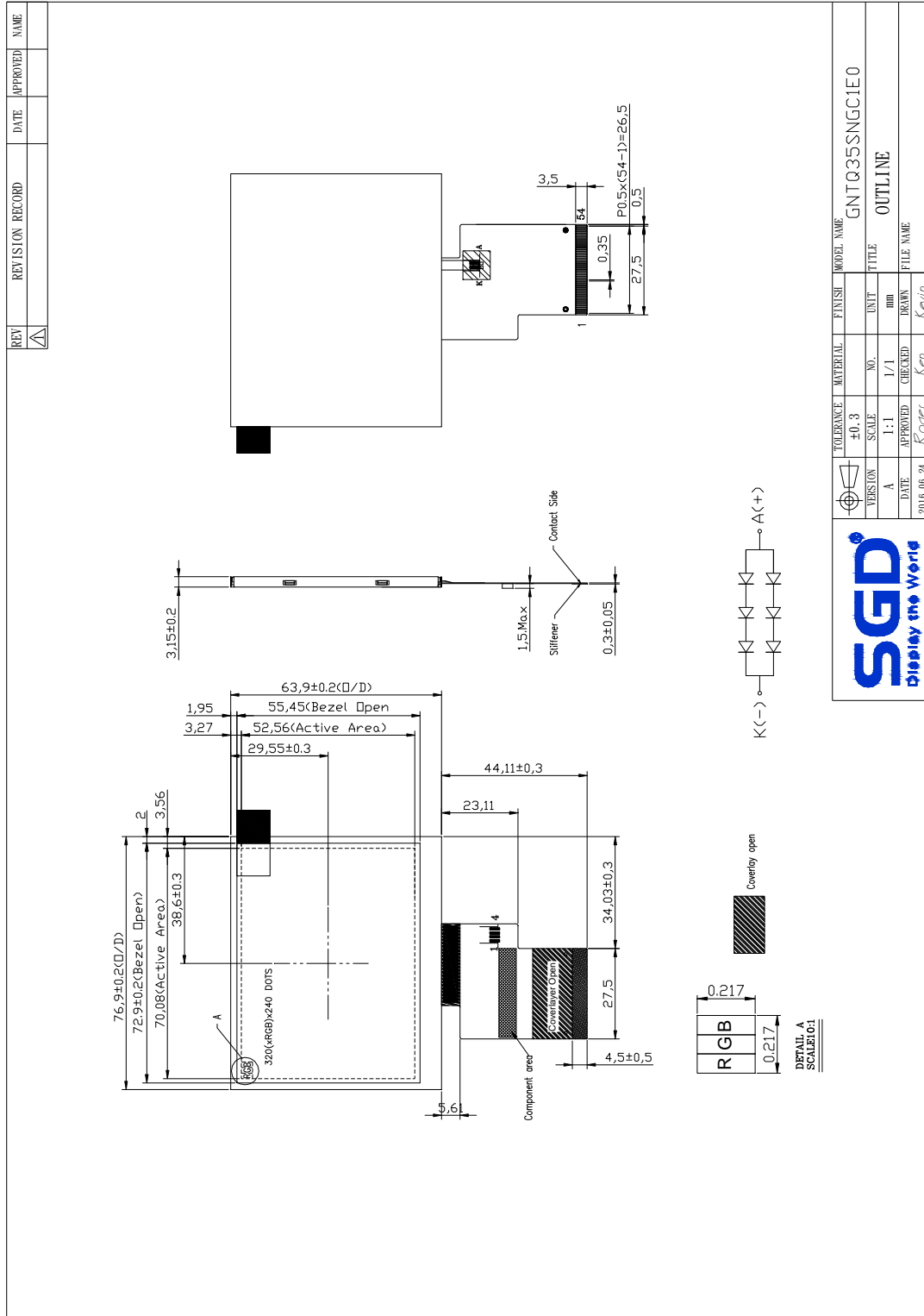

1.適用範圍/Description

此份文件適用於富相電子科技生產之 3.5”TFT 模組

This document shall be applied to TFT-LCD Module for 3.5”.

2.檢查條件與環境/ Inspection and Environment Conditions

2.1 檢查條件/ Inspection Conditions:

(1)檢測距離/Inspection Distance: 25cm~30cm

(2)觀看角度/ View Angle:

點燈檢驗角度/ Light-on Inspection Angle : ±5°

外觀檢驗角度/ Cosmetic Inspection Angle : ±45°

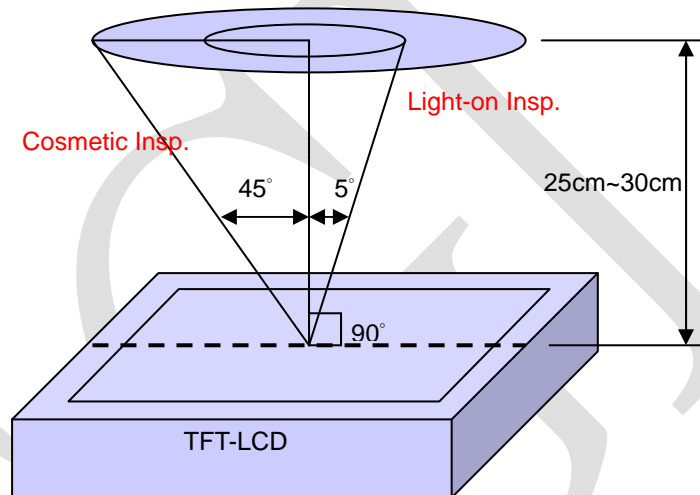

(垂直於液晶顯示表面/ perpendicular to LCD panel surface)

2.2 環境條件/Environment Conditions:

溫度/ Ambient Temperature		25°C±5°C
濕度/ Ambient Humidity		60±10%RH
亮度 Ambient Illumination	外觀檢驗 Cosmetic Inspection	100~150 Lux
	點燈檢驗 Functional Inspection	100~150 Lux

2.3 抽樣條件/Sampling Conditions:

(1) 批量：單次運送單一機種之數量

Lot Size: Quantity of shipment lot per model

(2) 抽樣方法/Sampling Method:

抽樣計畫 Sampling Plan		MIL-STD-105E
		正常檢驗、單次抽樣 Normal Inspection, Single Sampling
		Level II
AQL	主要缺點 Major Defect	1.0%
	次要缺點 Minor Defect	1.5%

(3) 主缺(MA)及次缺(MI)定義於”3.檢查標準”

The classification of Major(MA) and Minor(MI) defects is shown as 3. Inspection Criteria.

3. 檢查標準/ Inspection Criteria

3.1 外觀檢查(面板)/Cosmetic Inspection(Panel):

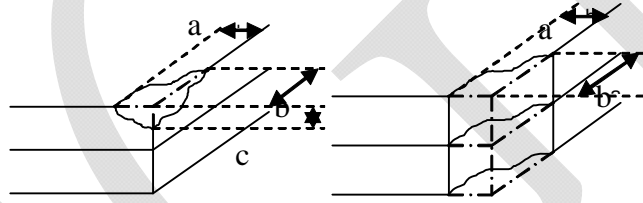
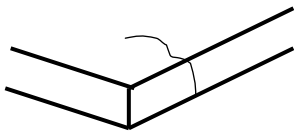
項目/ Item	判斷標準/ Judgment Criteria	分類/ Classification
面板/缺角 Chipping on Panel	 $a \leq 1.0\text{mm}$ 、 $b \leq 2.0\text{mm}$ 、 $c \leq t$ 單片玻璃厚度 (Bottom glass thickness)	MA
面板/表面刮傷 Scratch on Panel *Note-2	$W \leq 0.03\text{mm}$: Ignored/不計 $0.05\text{mm} < W \leq 0.1\text{mm}$ and $0.5\text{mm} < L \leq 2.5\text{mm}$: $N \leq 3$ $0.05\text{mm} < W \leq 0.1\text{mm}$ and $2.5\text{mm} < L \leq 15\text{mm}$: $N \leq 2$ $0.05\text{mm} < W \leq 0.1\text{mm}$ and $15\text{mm} < L \leq 20\text{mm}$: $N \leq 1$ $W > 0.1\text{mm}$: Not allowed/不允許	MI
面板/ 表面氣泡,凹痕 Bubble or Dent on Panel *Note-3	$D \leq 0.1\text{mm}$: Ignored/不計 $0.1\text{mm} < D \leq 0.3\text{mm}$: $N \leq 2$ (Two points 5mm MIN) $D > 0.3\text{mm}$: Not allowed/不允許	MI
面板/裂痕 Panel/Crack	 不允許裂痕/ Not Allowed crack	MA
鐵殼變型 Bezel Deformation	不允許明顯的變型 Obvious deformation is not allowed.	MI

鐵殼氧化 Bezel Oxidation	生鏽不可連續超過一公分(馬口鐵不保證) Not allowed if it rusts continuously over 1 cm (It is out of warranty with rusted tin plate)	MI
鐵殼刮傷 Bezel Scratch	鐵件無感刮傷忽略; 鐵件有感刮傷 $L \leq 10\text{mm}$, $W \leq 0.2\text{mm}$, $N \leq 3$	MI
鐵件壓痕/凹/凸點 (A面) Metal Squash Dent /Flange(Front Side)	$D(W) \leq 1.0\text{mm}$, $L \leq 3.0\text{mm}$, $N \leq 3$;	MI
背光高壓線裸露 B/L High Voltage Wire Denudation	不允許 Not allowed	MA
偏光片脫膠/殘膠/ 溢膠 Polarizer flaw or leak out resin	顯示領域範圍內不可 Defect is defined as the active area.	MI
外觀尺寸 Outline Dimension	需符合 Product Spec.所示之規格 Must in Spec, refer to related product spec.	MI

3.2 點燈檢查/ Functional Inspection:

項目/ Item	判斷標準/ Judgment Criteria			分類/ Classification
	Area(Note1)	I	O	
點缺陷 Point Defect	Bright dot 亮點	Random	2	
		2 dots adjacent	0	0
		3 dots adjacent or more	0	0
	Dark dot 暗點	Random	3	
		2 dots adjacent	0	
		3 dots adjacent or more	0	0
	Total Dot Defect 總數		4	
	Distance 距離	Distance between Bright and Bright dot	$L \geq 5\text{mm}$	
		Distance between Bright and Dark dot	$L \geq 5\text{mm}$	
		Distance between Dark dot	$L \geq 5\text{mm}$	
(1)缺陷大小 $> 0.5\text{dot}$ 定義為點缺陷 It is defined as Point Defect if defect area $> 0.5\text{dot}$ (2)缺陷大小 $\leq 0.5\text{dot}$ 不計 It is ignored if defect area $\leq 0.5\text{dot}$ (3)微弱亮透過 ND Filter 6% 仍可視計為點缺陷(全黑畫面檢查) Weak point defect will be defined as Bright Dot if it can be observed through ND filter 6% (Full Screen Black Inspection)				
線缺陷 Line Defect	不允許明顯的線缺陷 Obvious vertical or horizontal line defect is not allowed.			MA

Mura	不允許任何透過 ND Filter 6 % 仍可視之 Mura Not allowed if it can be observed through ND Filter 6 %	MI
點狀異物 Foreign Material in spot shape *Note-3	D ≤ 0.15mm: Ignored/不計 0.15mm < D ≤ 0.5mm: N ≤ 4 D > 0.5mm: Not allowed/不允許	MI
線狀異物 Foreign Material in line or spiral shape *Note-4	W ≤ 0.05mm or L ≤ 5mm: Ignored/不計 0.05mm < W ≤ 0.2mm and L 1.0mm ≤ 5mm: N ≤ 3 W > 0.2mm or L > 5mm: Not allowed/不允許	MI
顯示異常 Display Function Abnormal	不允許任何顯示異常 No Malfunction can be allowed	MA

Note-1 : I/O 區定義/ I/O Area Definition

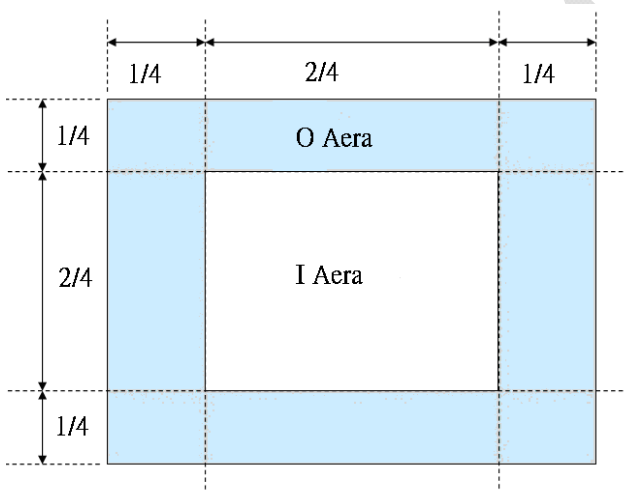

Note-2 : Polarizer 刮傷/ Polarizer Scratch

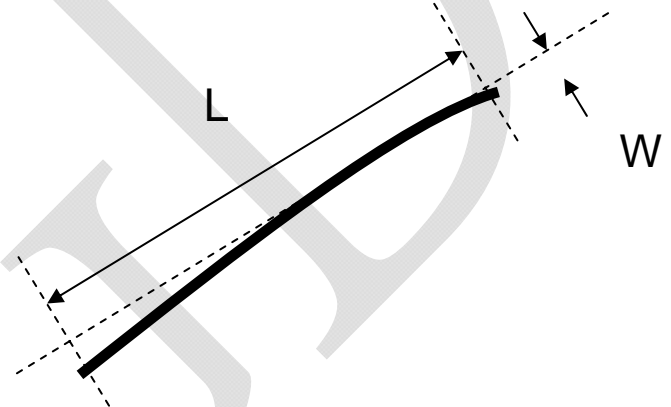

Note-3 : 點狀異物/ Spot Foreign Material
(W ≥ L / 4)

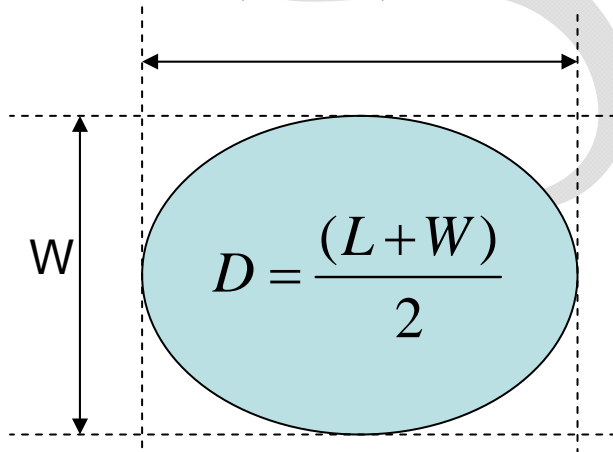

Note-4 : 線狀異物 Line or Spiral Foreign Material
(W < L / 4)

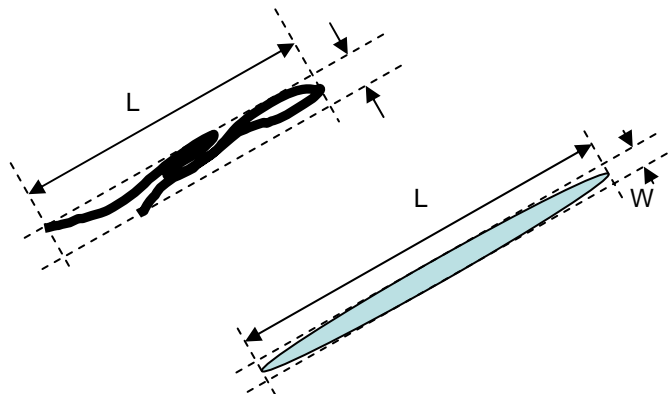

Our company network supports you worldwide with offices in Germany, Austria, Switzerland, the UK and the USA. For more information please contact:

Headquarters

Germany



FORTEC Elektronik AG

Lechwiesenstr. 9
86899 Landsberg am Lech

Phone: +49 8191 91172-0
E-Mail: sales@forteca.de
Internet: www.forteca.de

Fortec Group Members

Austria



FORTEC Elektronik AG

Office Vienna

Nuschinggasse 12
1230 Wien

Phone: +43 1 8673492-0
E-Mail: office@fortec.at
Internet: www.fortec.at

Germany



Distec GmbH

Augsburger Str. 2b
82110 Germering

Phone: +49 89 894363-0
E-Mail: info@distec.de
Internet: www.distec.de

Switzerland



ALTRAC AG

Bahnhofstraße 3
5436 Würenlos

Phone: +41 44 7446111
E-Mail: info@altrac.ch
Internet: www.altrac.ch

United Kingdom



Display Technology Ltd.

Osprey House, 1 Osprey Court
Hichingbrooke Business Park
Huntingdon, Cambridgeshire, PE29 6FN

Phone: +44 1480 411600
E-Mail: info@displaytechnology.co.uk
Internet: www.displaytechnology.co.uk

USA



Apollo Display Technologies, Corp.

87 Raynor Avenue,
Unit 1 Ronkonkoma,
NY 11779

Phone: +1 631 5804360
E-Mail: info@apolloDisplays.com
Internet: www.apolloDisplays.com