



OUR GLOBAL
COMPETENCE
CENTRES

 APOLLO DISPLAY
TECHNOLOGIES



 DISTEC



 DISPLAY
TECHNOLOGY



Datasheet

SGD

GKHG, \$AB: ; %9%

SG-01-0GH

Product Specification



	Model: GKTS80MNFG1E1	Rev. No.	Issued Date.	Page.
		C	2017, Sep.12	1 / 25

**Thin-Film-Transistor LCD Module
Model: GKTS80MNFG1E1**

Acceptance

Solomon Goldentek Display Corp.
NO. 18 Ta-Yeh St., Ta-Fa Industrial Park, Ta-Liao
Hsiang, Kaohsiung Hsien 831, TAIWAN , R.O.C.
FAX: 886-7-7886800

Approved and Checked by

Approved by	Checked by		Made by
			

Product Specification

	Model: GKTS80MNFG1E1	Rev. No.	Issued Date.	Page.
		C	2017, Sep.12	2 / 25

Revise Records

Rev.	Date	Contents	Written	Approved
A	2016/11/18	Preliminary Specification	Kevin Huang	Roger Yang
B	2017/5/12	Modify The Absolute Ratings of Environment	Alex	Roger Yang
C	2017/9/12	Add The Power supply current	Alex	Ken
		Add The Led power consumption		
		Add The Weight		
		Modify The Electrical Absolute Maximum Ratings		

Special Notes

Note1.	
Note2.	
Note3.	
Note4.	
Note5.	

Product Specification				
	Model: GKTS80MNFG1E1	Rev. No.	Issued Date.	Page.
		C	2017, Sep.12	3 / 25

Contents

- 1. General Description and Features 4**
- 1.1 Features 4
- 1.2 LCD Module 4
- 2. Mechanical Information 4**
- 3. Electrical Specifications 5**
- 3.1 Absolute Max. Ratings 5
- 4. Optical Characteristics 12**
- 4.1 Optical characteristic of the LCD 12
- 5. I/O Terminal 15**
- 5.1 Pin Assignment 15
- 5.2 Back-light 16
- 5.3 Block Diagram 16
- 6. Displayed Color and Input Data 17**
- 6.1 6 bit Input Data 17
- 6.2 8 bit Input Data 18
- 7. Reliability Condition 19**
- 8. Dimensional Outlines 20**
- 9. Incoming Inspection Standards 21**

Product Specification

	Model: GKTS80MNFG1E1	Rev. No.	Issued Date.	Page.
		C	2017, Sep.12	4 / 25

1. General Description and Features

GKTS80MNFG1E1 is a transmissive type color active matrix TFT (Thin Film Transistor) liquid crystal display (LCD) that uses amorphous silicon TFT as a switching device. This model is composed of a TFT-LCD module, a receiver circuit, and a back-light unit. Graphics and texts can be displayed on 1600 (W) x 3 x 480 (H) dots (10:3 aspect ratio) with 262,144/16.2M colors by supplying 18/24 bits data signal (6/8 bits each color). The following table described the features of GKTS80MNFG1E1.

1.1 Features

- Transmissive.
- IPS mode.
- LVDS Receiver 18/24 bit Interface.
- Back-light Dimming control

1.2 LCD Module

Item	Specification	Unit
Screen Size	8 inches	Diagonal
Display Resolution	1600 (H) x 480 (V)	Pixel
Active Area	194.40 (H) x 58.32 (V)	mm
Outline Dimension	208.0 (H) x 73.0 (V) x 8.5 (T)	mm
Display Mode	Normally Black mode/ Transmissive	--
Surface Treatment	Clear,3H	--
Pixel Arrangement	R,G,B Vertical Stripe	--
Pixel Size	0.1215 x 0.1215	mm
Display Color	16.7M	--
Viewing Direction	MVA	--
Input Interface	LVDS	--

2. Mechanical Information

Item		Min.	Typ.	Max.	Unit	Note
Module Size	Horizontal (H)	206	208	210	mm	(1)
	Vertical (V)	72.8	73	73.2	mm	
	Thickness (T)	8.3	8.5	8.7	mm	
Weight			128		g	--

Note (1) Please refer to the attached drawings for more information of front and back outline dimensions.

Product Specification

	Model: GKTS80MNFG1E1	Rev. No.	Issued Date.	Page.
		C	2017, Sep.12	5 / 25

3. Electrical Specifications

3.1 Absolute Max. Ratings

3.1.1 Absolute Ratings of Environment

If the operating condition exceeds the following absolute maximum ratings, the TFT LCD module may be damaged permanently.

Item	Symbol	Min.	Max.	Unit	Note
Storage temperature	T_{STG}	-30	80	°C	(1)
Operating temperature	T_{OPR}	-20	70	°C	(1,2,3)

Note (1) 90 % RH Max. ($40\text{ °C} \geq T_a$). Maximum wet-bulb temperature at 39 °C or less. ($T_a > 40\text{ °C}$) No condensation.

Note (2) In case of below 0° , the response time of liquid crystal (LC) becomes slower and the color of panel becomes darker than normal one. Level of retardation depends on temperature, because of LC's character

Note (3) Only operation is guaranteed at operating temperature. Contrast, response time, another display quality are evaluated at $+25^\circ\text{C}$.

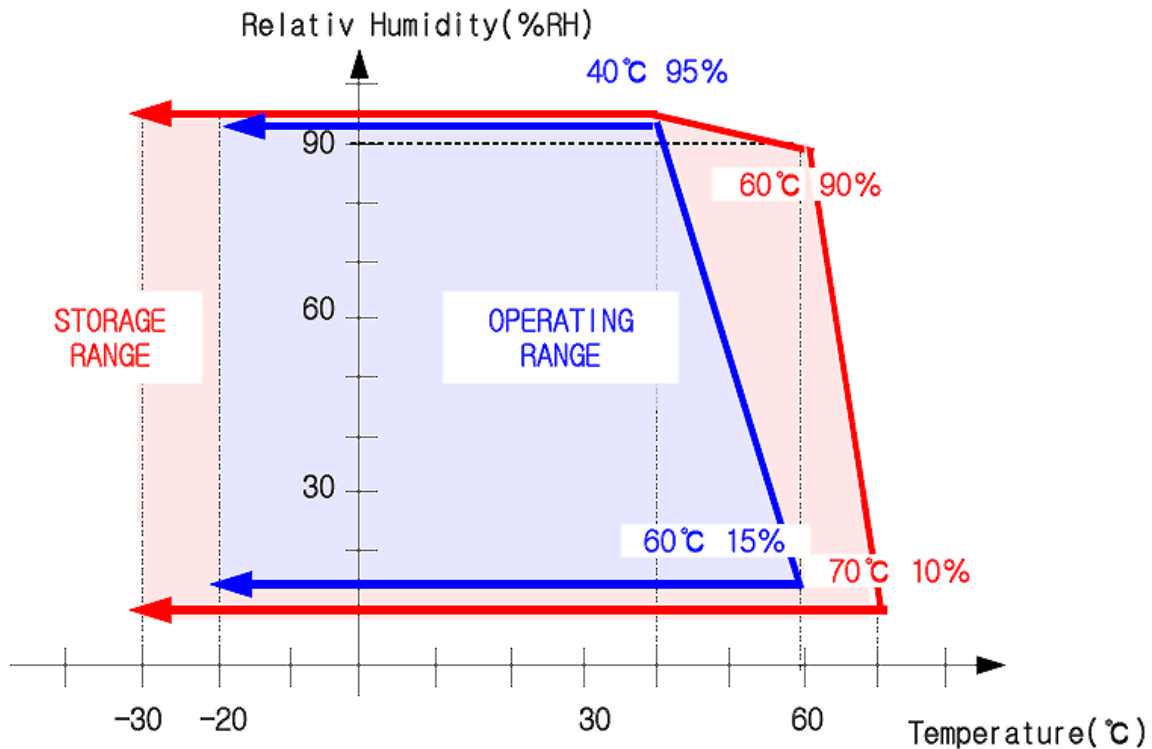

Product Specification

	Model: GKTS80MNFG1E1	Rev. No.	Issued Date.	Page.
		C	2017, Sep.12	6 / 25

3.1.2 Electrical Absolute Maximum Ratings

($V_{SS}=GND=0$)

Parameter	Symbol	Min.	Max.	Unit	Remark
Power supply voltage	VDD	-0.3	3.6	V	(1)
Power supply LED voltage	VLED	-0.3	18	V	(1),(2)
Enable Voltage	EN	--	5.5	V	
Back-light Adjust	ADJ	--	5.5	V	

Note (1) Permanent damage to the device may occur if maximum values are exceeded. Function operation should be restricted to the conditions described under Normal Operating Conditions.

Note (2) Specified values are for LED Driver (Refer to 3.2 for further information).

3.1.3 DC Electrical Characteristics of the TFT LCD

($T_a=25\pm 2^\circ\text{C}$, $GND=0$)

Item	Symbol	Min.	Typ.	Max.	Unit	Remark
Power Supply Voltage	VDD	3.0	3.3	3.6	V	
Power Supply Current	White	IDD	--	110	--	mA
	Black		--	70	--	mA
Power Consumption	P_L	-	-	1	W	
LVDS differential input voltage	VID	200	-	600	mV	
LVDS common input voltage	VICM	1	1.2	$1.7- VID /2$	V	

Note (1) The assembly should be always operated within above ranges.

Note (2) The specified power supply current is under the conditions at $VDD = 3.3V$, $T_a = 25 \pm 2^\circ\text{C}$, $f_v = 60\text{ Hz}$, whereas a power dissipation check pattern below is displayed.

a. White Pattern

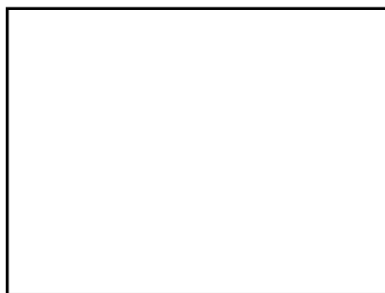

Active Area

b. Black Pattern

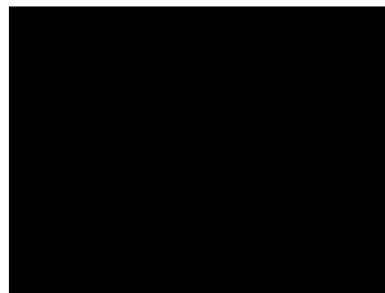

Active Area

Product Specification

	Model: GKTS80MNFG1E1	Rev. No.	Issued Date.	Page.
		C	2017, Sep.12	7 / 25

3.1.4 DC Electrical Characteristics of the Back-light Unit

(Ta=25±2°C, GND=0)

Item	Symbol	Min.	Typ.	Max.	Unit	Remark	
Power supply LED Voltage	VLED	10.8	12.0	13.2	V	(Duty 100%)	
Power supply LED Current	ILED	-	0.2	0.25	A	VLED=12V (Duty 100%)	
LED Power Consumption	P _{LED}	-	2.4	3.3	W	VLED=12V (Duty 100%)	
EN Control Level	V _{ON}	-	0.7	-	5	V	
	V _{OFF}	-	0	-	0.4	V	
PWM Control Level	High	-	2.0	-	5	V	
	Low	-	0	-	0.15	V	
PWM Control Duty Ratio	-	2	-	100	%	(2)	
PWM Control Frequency	f _{PWM}	100	-	1K	Hz	(2)	
LED Life Time	L _L	30,000	-	-	Hrs	(3)	

Note (1) LED current is measured by utilizing a high frequency current meter as shown below:

Note (3) The "LED life time" is defined as the module brightness decrease to 50% original brightness at Ta=25°C and IL=75mA. The LED lifetime could be decreased if operating IL is larger than 75mA. The constant current driving method is suggested.

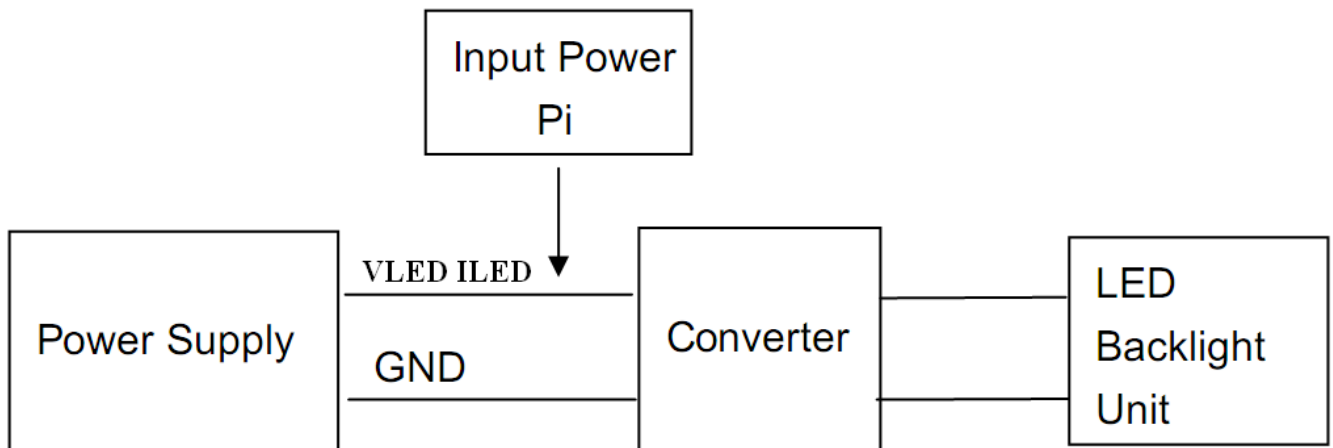

Product Specification

	Model: GKTS80MNF1E1	Rev. No.	Issued Date.	Page.
		C	2017, Sep.12	8 / 25

3.1.5 AC Timing Condition

Signal	Parameter	Symbol	Min.	Typ.	Max.	Unit.	Remark
DCLK	CLK frequency	F_C	48.69	52.59	60.83	MHz	
Horizontal Timing	Total	T_h	1656	1660	1760	Tc	$T_h = T_{hd} + T_{hb}$
	Display	T_{hd}	-	1600	-	Tc	
	Blank	T_{hb}	56	60	160	Tc	
Vertical Timing	Total	T_v	490	528	576	Th	$T_v = T_{vd} + T_{vb}$
	Display	T_{vd}	-	480	-	Th	
	Blank	T_{vb}	10	480	96	Th	

Note (1) Since this assembly is operated in DE only mode, Hsync and Vsync input signals should be set to Vertical blanking logic level. Otherwise, this assembly would operate abnormally.

(2) Frame rate is 60Hz

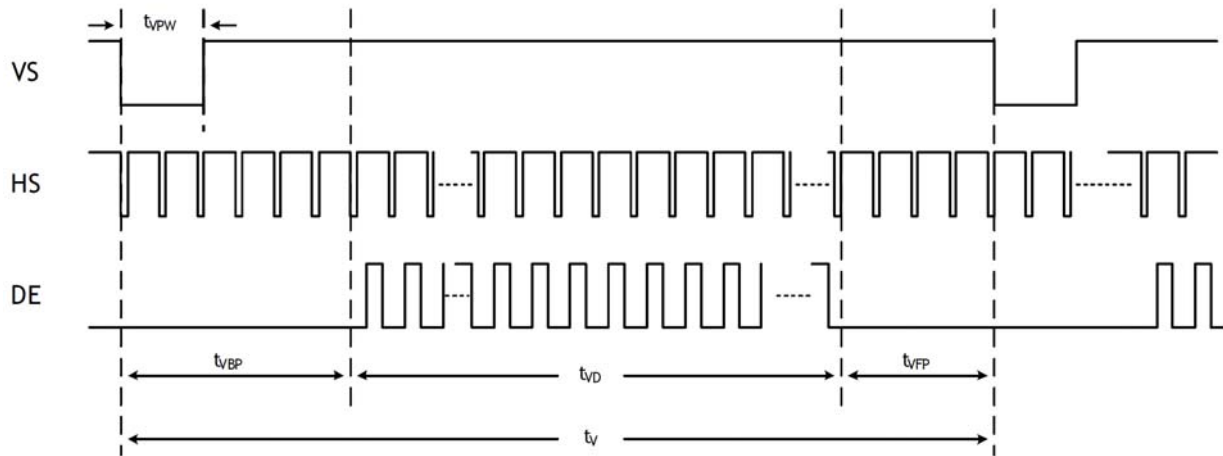

Horizontal input timing

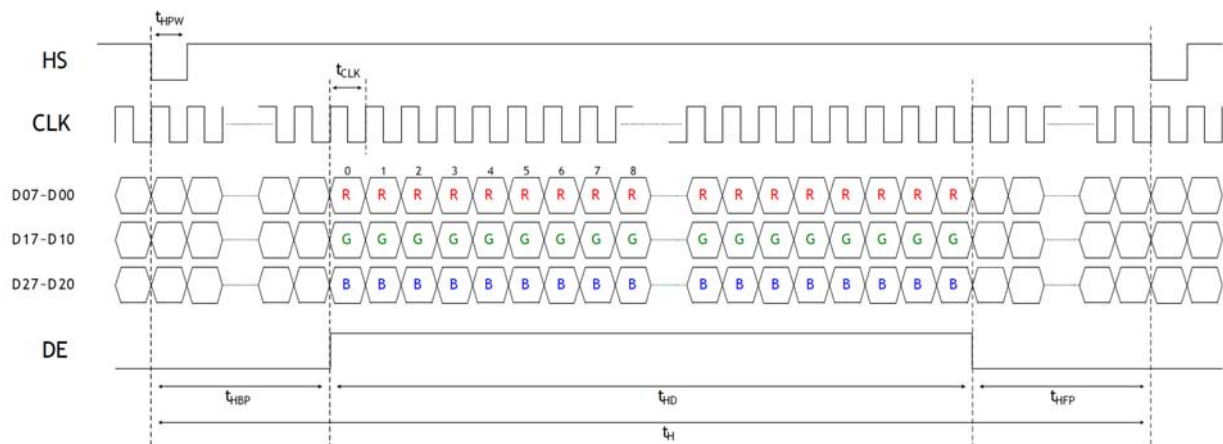

Product Specification

	Model: GKTS80MNFG1E1	Rev. No.	Issued Date.	Page.
		C	2017, Sep.12	9 / 25

3.1.6 Timing Characteristic

6bit LVDS input (SEL 6/8 = 'GND')

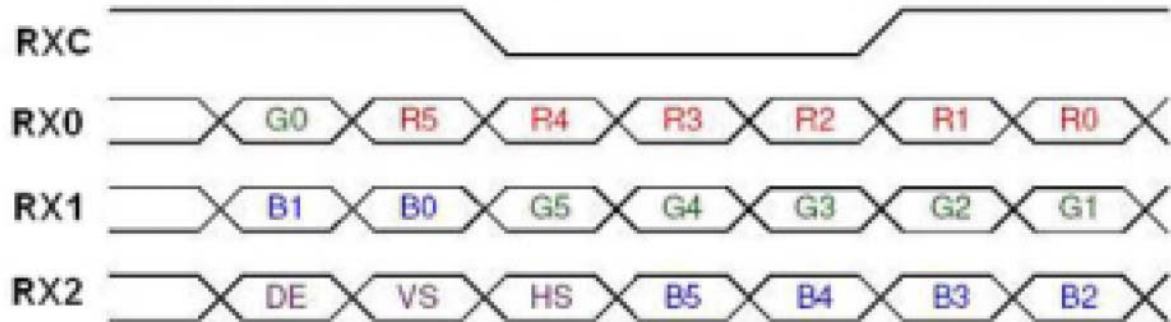

8bit LVDS input (SEL 6/8 = 'VDD')

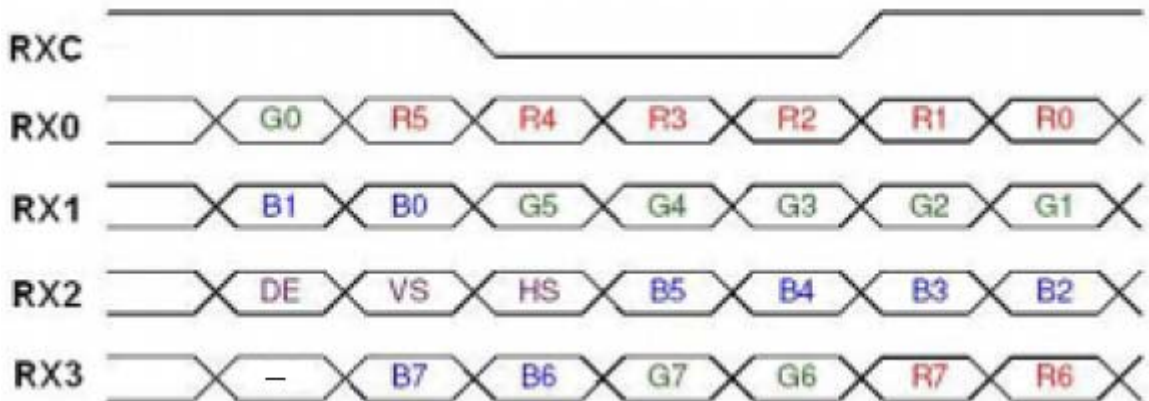

Note (1) R/G/B data 7: MSB, R/G/B data 0: LSB

Note (2) Please follow PSWG

Product Specification

	Model: GKTS80MNFG1E1	Rev. No.	Issued Date.	Page.
		C	2017, Sep.12	10 / 25

Signal Name	Description	Remark
R7 R0	Red Data 7(MSB) Red Data 0(LSB)	Red-pixel Data Each red pixel's brightness data consists of these 8 bits pixel data.
G7 G0	Green Data 7(MSB) Green Data 0(LSB)	Green-pixel Data Each green pixel's brightness data consists of these 8 bits pixel data.
B7 B0	Blue Data 7(MSB) Blue Data 0(LSB)	Blue-pixel Data Each blue pixel's brightness data consists of these 8 bits pixel data.
RXCLKIN+ RXCLKIN-	LVDS Clock Input	
DE	Display Enable	
VS	Vertical Sync	
HS	Horizontal Sync	

Note (4) Output signals from any system shall be low or Hi-Z state when VCC is off.

Product Specification

	Model: GKTS80MNFG1E1	Rev. No.	Issued Date.	Page.
		C	2017, Sep.12	11 / 25

3.1.7 Power On/Off Sequence

To prevent a latch-up or DC operation of LCD assembly, the power on/off sequence should be as the diagram below.

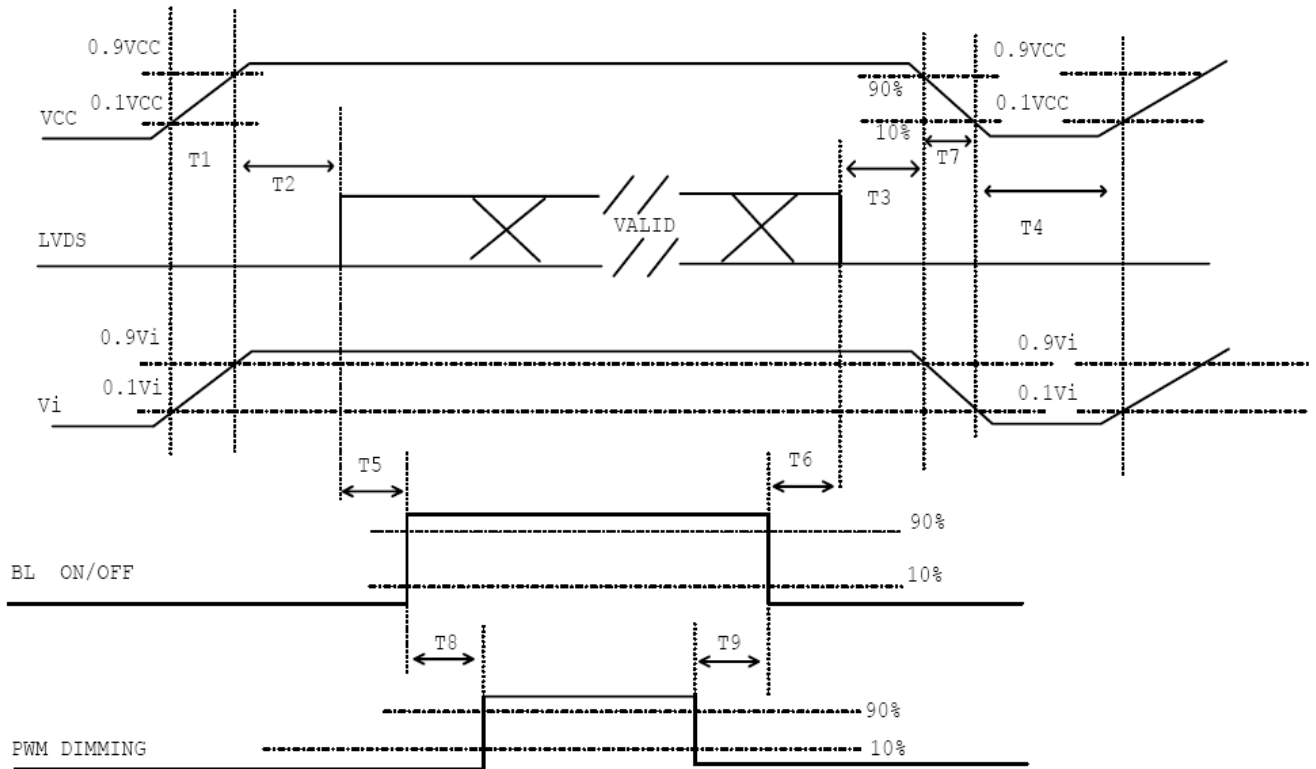

Note (1) Please avoid floating state of interface signal at invalid period.

Note (2) When the interface signal is invalid; be sure to pull down the power supply of LCD VCC to 0 V.

Note (3) The Backlight converter power must be turned on after the power supply for the logic and the interface signal is valid. The Backlight converter power must be turned off before the power supply for the logic and the interface signal is invalid.

Parameter	Value			Units
	Min.	Typ.	Max.	
T1	0.5	-	10	ms
T2	0	-	50	ms
T3	0	-	50	ms
T4	500	-	-	ms
T5	200	-	-	ms
T6	20	-	-	ms
T7	5	-	300	ms
T8	10	-	-	ms
T9	10	-	-	ms

Product Specification

	Model: GKTS80MNFG1E1	Rev. No.	Issued Date.	Page.
		C	2017, Sep.12	12 / 25

4. Optical Characteristics

4.1 Optical characteristic of the LCD

The following items are measured under stable conditions. The optical characteristics should be measured in a dark room or equivalent state with the methods.

Measuring equipment: BM-7A

Ta=25±2°C ;Ha=50±10%RH

Item	Symbol	Condition	Min	Type	Max	Unit	Note
Brightness	B		400	500	--	cd/m ²	
Response time	Tr+Tf	θ=0°	-	25	35	ms	
Contrast ratio	CR	At optimized viewing angle	700	900	--	--	
Luminance Uniformity	ΔL		70	80		%	
Color Chromaticity (CIE 1931)	White	x	0.301	0.304	0.307	-	BM-7A
		y	0.333	0.336	0.339	-	
Viewing Angle	Hor.	θ _R	--	85	--	Degree	
		θ _L	--	85	--		
	Ver.	θ _U	--	85	--		
		θ _D	--	85	--		

Product Specification

	Model: GKTS80MNFG1E1	Rev. No.	Issued Date.	Page.
		C	2017, Sep.12	13 / 25

a. Test equipment setup

After stabilizing and leaving the panel alone shall be warmed up for the stable operation of LCM, the measurement should be executed. Measurement should be executed in a stable, windless, and dark room. Optical specifications are measured by Topcon BM-7A(fast) with a viewing angle of 2° at a distance of 50cm and normal direction.

b. Definition of response time: Tr and Tf

The response time is defined as the following figure and shall be measured by switching the input signal for "black" and "white".

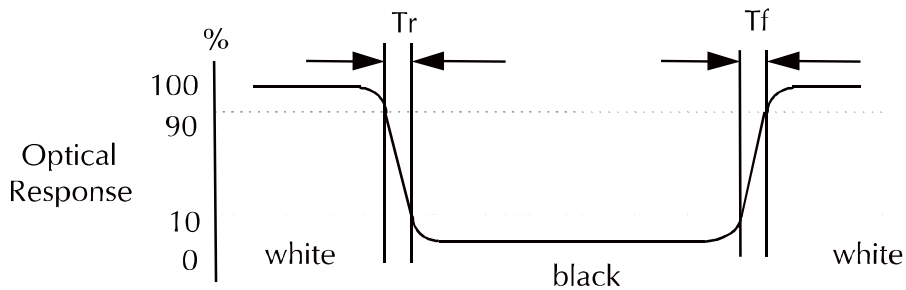

c. Definition of contrast ratio:

$$\text{Contrast Ratio (CR)} = \frac{\text{Brightness measured when LCD is at "white state"}}{\text{Brightness measured when LCD is at "black state"}}$$

d. Measured at the center area of the panel when all the input terminals of LCD panel are electrically opened.

Product Specification

	Model: GKTS80MNFG1E1	Rev. No.	Issued Date.	Page.
		C	2017, Sep.12	14 / 25

e. View Angle

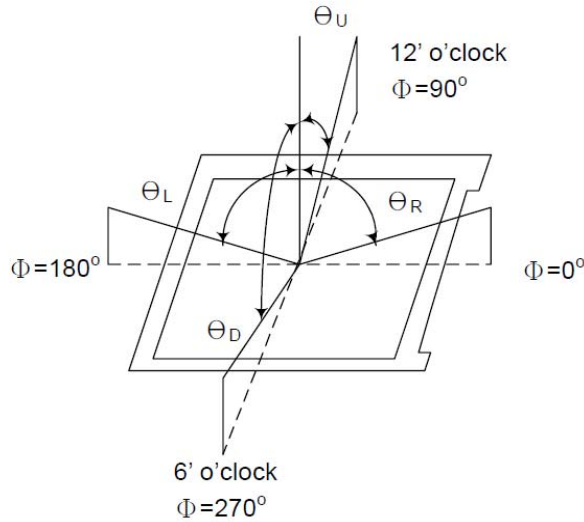

f. Definition of Luminance of White: Luminance of white at the center points

Light Source of Back-Light Unit	LED Type
---------------------------------	----------

g. Definition of White Uniformity

$$\text{White Uniformity} = \frac{\text{Min. luminance of white among 5-points}}{\text{Max. luminance of white among 5-points}} \times 100\%$$

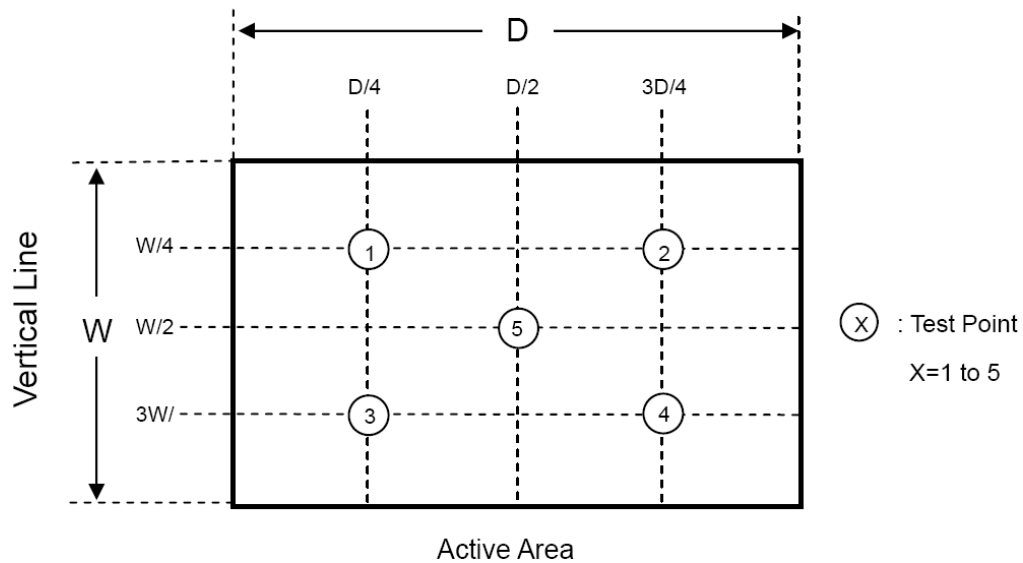

Product Specification

	Model: GKTS80MNFG1E1	Rev. No.	Issued Date.	Page.
		C	2017, Sep.12	15 / 25

5. I/O Terminal

5.1 Pin Assignment

(CN2 connector: MSB24013P20HA or equivalent.)

Pin No.	Symbol	I/O	Function	Remark
1	VDD	P	Power Supply for LCD	
2	VDD	P	Power Supply for LCD	
3	SELB	I	6bit/8bit mode select	Note (1)
4	GND	P	Ground	
5	RXIND0-	I	Negative LVDS differential data input	
6	RXIND0+	I	Positive LVDS differential data input	
7	GND	P	Ground	
8	RXIND1-	I	Negative LVDS differential data input	
9	RXIND1+	I	Positive LVDS differential data input	
10	GND	P	Ground	
11	RXIND2-	I	Negative LVDS differential data input	
12	RXIND2+	I	Positive LVDS differential data input	
13	GND	P	Ground	
14	RXCLKIN-	I	Negative LVDS differential clock input	
15	RXCLKIN+	I	Positive LVDS differential clock input	
16	GND	P	Ground	
17	RXIND3-	I	Negative LVDS differential data input	
18	RXIND3+	I	Positive LVDS differential data input	
19	GND	P	Ground	
20	GND	P	Ground	

I: Input, O: Output, P: Power

Note (1) When use 6bit Input mode: SEL 6/8 = GND

When use 8bit Input mode: SEL 6/8 = VDD

Product Specification

	Model: GKTS80MNFG1E1	Rev. No.	Issued Date.	Page.
		C	2017, Sep.12	16 / 25

5.2 Back-light

(CN3: 3808K-F05N-03L or Equivalent)

Pin No.	Symbol	I/O	Function	Remark
1	VLED	P	Power Supply voltage	
2	GND	P	Ground	
3	ON/OFF	I	Backlight ON/OFF Control	
4	PWM	I	Backlight Dimming Control	
5	GND	P	Ground	

5.3 Block Diagram

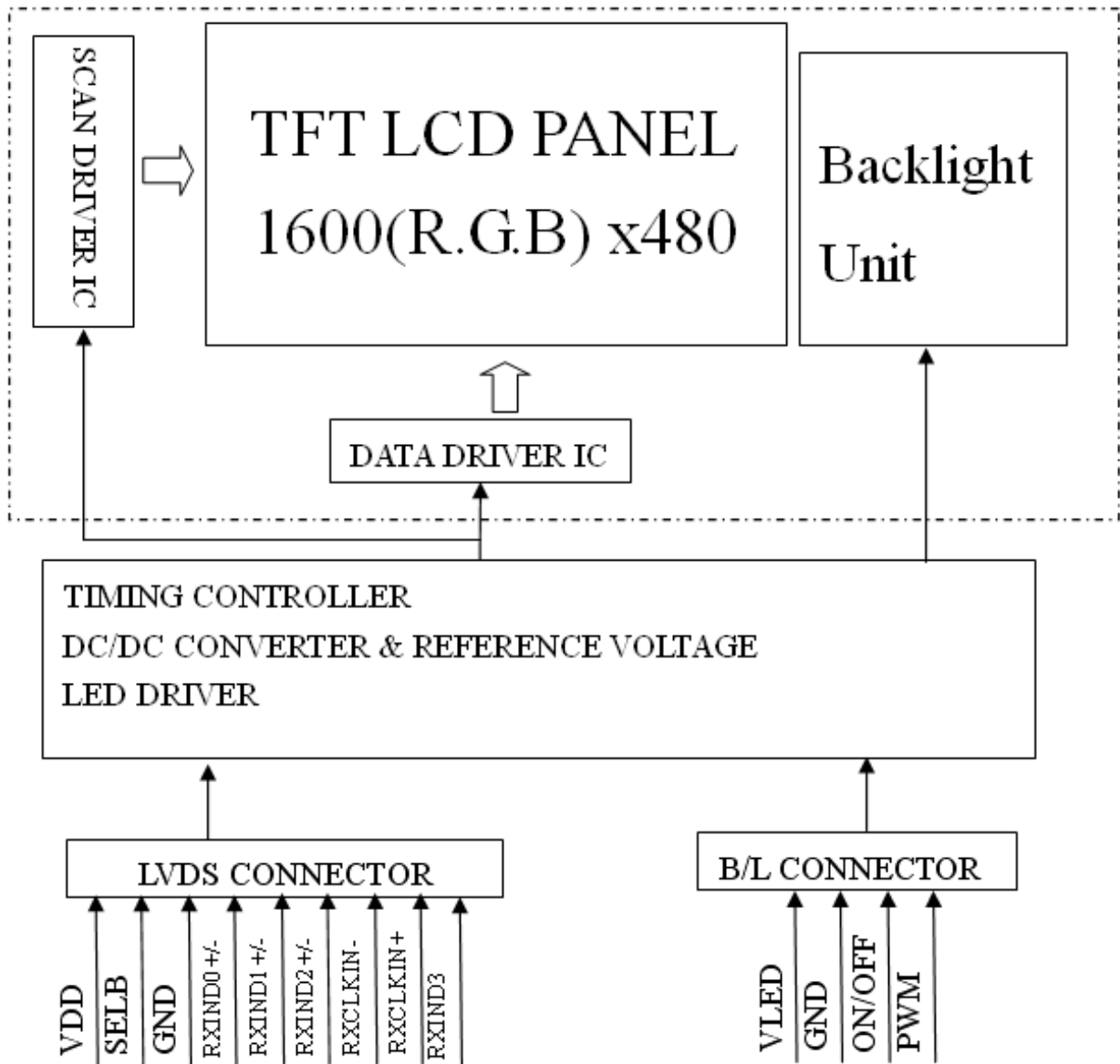

Product Specification

	Model: GKTS80MNFG1E1	Rev. No.	Issued Date.	Page.
		C	2017, Sep.12	17 / 25

6. Displayed Color and Input Data

6.1 6 bit Input Data

	Color & Gray Scale	Data Signal																	
		R5	R4	R3	R2	R1	R0	G5	G4	G3	G2	G1	G0	B5	B4	B3	B2	B1	B0
Basic Color	Black	0	0	0	0	0	0	0	0	0	0	0	0	0	0	0	0	0	0
	Red(0)	1	1	1	1	1	1	0	0	0	0	0	0	0	0	0	0	0	0
	Green(0)	0	0	0	0	0	0	1	1	1	1	1	1	0	0	0	0	0	0
	Blue(0)	0	0	0	0	0	0	0	0	0	0	0	0	1	1	1	1	1	1
	Cyan	0	0	0	0	0	0	1	1	1	1	1	1	1	1	1	1	1	1
	Magenta	1	1	1	1	1	1	0	0	0	0	0	0	1	1	1	1	1	1
	Yellow	1	1	1	1	1	1	1	1	1	1	1	1	0	0	0	0	0	0
	White	1	1	1	1	1	1	1	1	1	1	1	1	1	1	1	1	1	1
Red	Black	0	0	0	0	0	0	0	0	0	0	0	0	0	0	0	0	0	0
	Red(62)	0	0	0	0	0	1	0	0	0	0	0	0	0	0	0	0	0	0
	Red(61)	0	0	0	0	1	0	0	0	0	0	0	0	0	0	0	0	0	0
	:	:	:	:	:	:	:	:	:	:	:	:	:	:	:	:	:	:	:
	Red(31)	0	1	1	1	1	1	0	0	0	0	0	0	0	0	0	0	0	0
	:	:	:	:	:	:	:	:	:	:	:	:	:	:	:	:	:	:	:
	Red(1)	1	1	1	1	1	0	0	0	0	0	0	0	0	0	0	0	0	0
	Red(0)	1	1	1	1	1	1	0	0	0	0	0	0	0	0	0	0	0	
Green	Black	0	0	0	0	0	0	0	0	0	0	0	0	0	0	0	0	0	0
	Green(62)	0	0	0	0	0	0	0	0	0	0	0	1	0	0	0	0	0	0
	Green(61)	0	0	0	0	0	0	0	0	0	0	1	0	0	0	0	0	0	0
	:	:	:	:	:	:	:	:	:	:	:	:	:	:	:	:	:	:	:
	Green(31)	0	0	0	0	0	0	0	1	1	1	1	0	0	0	0	0	0	0
	:	:	:	:	:	:	:	:	:	:	:	:	:	:	:	:	:	:	:
	Green(1)	0	0	0	0	0	0	1	1	1	1	1	0	0	0	0	0	0	0
	Green(0)	0	0	0	0	0	0	1	1	1	1	1	1	0	0	0	0	0	
Blue	Black	0	0	0	0	0	0	0	0	0	0	0	0	0	0	0	0	0	0
	Blue(62)	0	0	0	0	0	0	0	0	0	0	0	0	0	0	0	0	0	1
	Blue(61)	0	0	0	0	0	0	0	0	0	0	0	0	0	0	0	0	1	0
	:	:	:	:	:	:	:	:	:	:	:	:	:	:	:	:	:	:	:
	Blue(31)	0	0	0	0	0	0	0	0	0	0	0	0	0	1	1	1	1	1
	:	:	:	:	:	:	:	:	:	:	:	:	:	:	:	:	:	:	:
	Blue(1)	0	0	0	0	0	0	0	0	0	0	0	0	1	1	1	1	1	0
	Blue(0)	0	0	0	0	0	0	0	0	0	0	0	1	1	1	1	1	1	

0 : Low level voltage, 1 :High level voltage

Each basic color can be displayed in 64 gray scales from 6 bit data signals. With the combination of total 18 bit data signals, the 262,144-color display can be achieved on the screen.

Product Specification

	Model: GKTS80MNFG1E1	Rev. No.	Issued Date.	Page.
		C	2017, Sep.12	18 / 25

6.2 8 bit Input Data

	Color & Gray Scale	Data Signal																							
		R7	R6	R5	R4	R3	R2	R1	R0	G7	G6	G5	G4	G3	G2	G1	G0	B7	B6	B5	B4	B3	B2	B1	B0
Basic Color	Black	0	0	0	0	0	0	0	0	0	0	0	0	0	0	0	0	0	0	0	0	0	0	0	0
	Red(0)	1	1	1	1	1	1	1	1	0	0	0	0	0	0	0	0	0	0	0	0	0	0	0	0
	Green(0)	0	0	0	0	0	0	0	0	1	1	1	1	1	1	1	1	0	0	0	0	0	0	0	0
	Blue(0)	0	0	0	0	0	0	0	0	0	0	0	0	0	0	0	0	1	1	1	1	1	1	1	1
	Cyan	0	0	0	0	0	0	0	0	1	1	1	1	1	1	1	1	1	1	1	1	1	1	1	1
	Magenta	1	1	1	1	1	1	1	1	0	0	0	0	0	0	0	0	1	1	1	1	1	1	1	1
	Yellow	1	1	1	1	1	1	1	1	1	1	1	1	1	1	1	1	0	0	0	0	0	0	0	0
	White	1	1	1	1	1	1	1	1	1	1	1	1	1	1	1	1	1	1	1	1	1	1	1	1
Red	Black	0	0	0	0	0	0	0	0	0	0	0	0	0	0	0	0	0	0	0	0	0	0	0	
	Red(255)	0	0	0	0	0	0	0	1	0	0	0	0	0	0	0	0	0	0	0	0	0	0	0	
	Red(254)	0	0	0	0	0	0	1	0	0	0	0	0	0	0	0	0	0	0	0	0	0	0	0	
	:	:	:	:	:	:	:	:	:	:	:	:	:	:	:	:	:	:	:	:	:	:	:	:	
	Red(31)	0	0	0	1	1	1	1	1	0	0	0	0	0	0	0	0	0	0	0	0	0	0	0	
	:	:	:	:	:	:	:	:	:	:	:	:	:	:	:	:	:	:	:	:	:	:	:	:	
	Red(1)	1	1	1	1	1	1	1	0	0	0	0	0	0	0	0	0	0	0	0	0	0	0	0	
	Red(0)	1	1	1	1	1	1	1	1	0	0	0	0	0	0	0	0	0	0	0	0	0	0	0	
Green	Black	0	0	0	0	0	0	0	0	0	0	0	0	0	0	0	0	0	0	0	0	0	0	0	
	Green(255)	0	0	0	0	0	0	0	0	0	0	0	0	0	0	0	1	0	0	0	0	0	0	0	
	Green(254)	0	0	0	0	0	0	0	0	0	0	0	0	0	0	1	0	0	0	0	0	0	0	0	
	:	:	:	:	:	:	:	:	:	:	:	:	:	:	:	:	:	:	:	:	:	:	:	:	
	Green(31)	0	0	0	0	0	0	0	0	0	0	0	1	1	1	1	0	0	0	0	0	0	0	0	
	:	:	:	:	:	:	:	:	:	:	:	:	:	:	:	:	:	:	:	:	:	:	:	:	
	Green(1)	0	0	0	0	0	0	0	0	1	1	1	1	1	1	1	0	0	0	0	0	0	0	0	
	Green(0)	0	0	0	0	0	0	0	0	1	1	1	1	1	1	1	0	0	0	0	0	0	0	0	
Blue	Black	0	0	0	0	0	0	0	0	0	0	0	0	0	0	0	0	0	0	0	0	0	0	0	
	Blue(255)	0	0	0	0	0	0	0	0	0	0	0	0	0	0	0	0	0	0	0	0	0	0	1	
	Blue(254)	0	0	0	0	0	0	0	0	0	0	0	0	0	0	0	0	0	0	0	0	0	0	1	
	:	:	:	:	:	:	:	:	:	:	:	:	:	:	:	:	:	:	:	:	:	:	:	:	
	Blue(31)	0	0	0	0	0	0	0	0	0	0	0	0	0	0	0	0	0	0	0	1	1	1	1	
	:	:	:	:	:	:	:	:	:	:	:	:	:	:	:	:	:	:	:	:	:	:	:	:	
	Blue(1)	0	0	0	0	0	0	0	0	0	0	0	0	0	0	0	1	1	1	1	1	1	1	0	
	Blue(0)	0	0	0	0	0	0	0	0	0	0	0	0	0	0	0	1	1	1	1	1	1	1	1	

0 : Low level voltage, 1 :High level voltage

Each basic color can be displayed in 256 gray scales from 6 bit data signals. With the combination of total 24 bit data signals, the 16.2M-color display can be achieved on the screen.

Product Specification

	Model: GKTS80MNFG1E1	Rev. No.	Issued Date.	Page.
		C	2017, Sep.12	19 / 25

7. Reliability Condition

No change on display and in operation under the following test condition.

Condition: Unless otherwise specified, tests will be conducted under the following condition.

Temperature: 20±5°C.

Humidity: 50±10%RH.

Tests will be not conducted under functioning state.

No.	Parameter	Condition	Notes
1	High Temperature Operating	70°C, 120hrs (Operation state).	
2	Low Temperature Operating	-20°C, 120hrs (Operation state).	1
3	High Temperature Storage	80°C, 120hrs.	2
4	Low Temperature Storage	-30°C, 120hrs.	1,2
5	High Temperature and High Humidity Operation Test	60°C, 90%, 120hrs.	1,2
6	Thermal Shock Storage Test	-30°C/30 min ~ +80°C/30 min for a total 25 cycles, Start with cold temperature and end with high temperature.	1,2
7	Vibration(Non-Operating)	1.5G, 0 ~ 55 Hz, 11min/cycle, 6 cycles each X, Y, Z	3

- Notes:
1. No dew condensation to be observed.
 2. The function test shall be conducted after 4 hours storage at the normal temperature and humidity after removed from the test chamber.
 3. Vibration test will be conducted to the product itself without putting I in a container.

Product Specification



Model: GKTS80MNFG1E1

Rev. No.

Issued Date.

Page.

C

2017, Sep.12

20 / 25

8. Dimensional Outlines

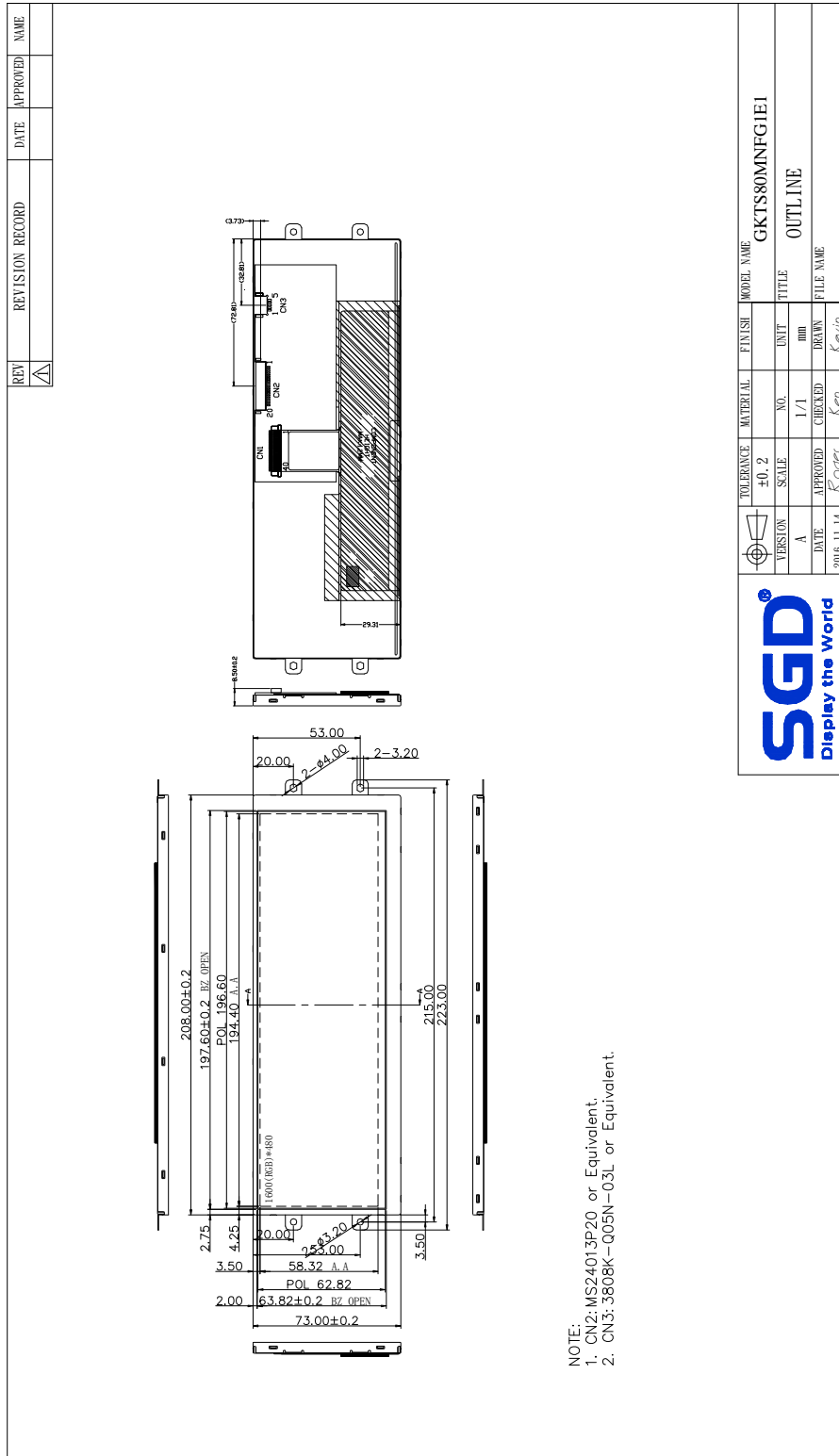

Product Specification

	Model: GKTS80MNFG1E1	Rev. No.	Issued Date.	Page.
		C	2017, Sep.12	21 / 25

9. Incoming Inspection Standards

9.1 Inspection and Environment Conditions

9.1.1 Inspection Conditions:

(1) Inspection Distance: 35 cm ± 5 cm

(2) View Angle:

Light-on Inspection Angle : ± 5°

Cosmetic Inspection Angle : ± 45°

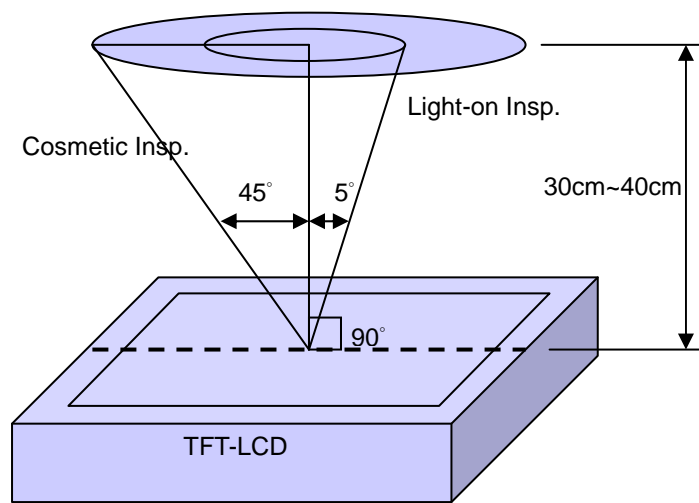

(Perpendicular to LCD panel surface)

9.1.2 Environment Conditions:

Ambient Temperature		23°C ± 5°C
Ambient Humidity		55 ± 10% RH
Ambient Illumination	Cosmetic Inspection	more than 600 Lux
	Functional Inspection	300~500 Lux

Product Specification

	Model: GKTS80MNFG1E1	Rev. No.	Issued Date.	Page.
		C	2017, Sep.12	22 / 25

9.1.3 Sampling Conditions:

- (1) Lot Size: Quantity of shipment lot per model
- (2) Sampling Method:

Sampling Plan		MIL-STD-105E
		Normal Inspection, Single Sampling
		Level II
AQL	Major Defect	1.0%
	Minor Defect	1.5%

(3) The classification of Major (MA) and Minor (MI) defects is shown as 11.2 Inspection Criteria.

9.2 Inspection Criteria

11.2.1 Cosmetic Inspection(Panel):

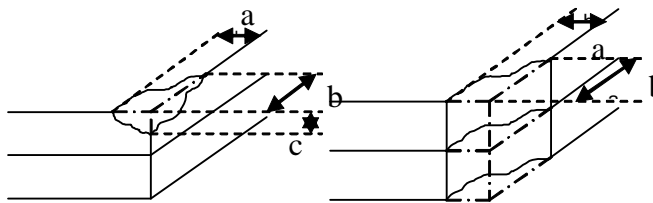
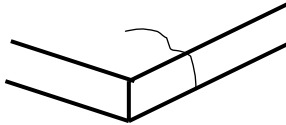
Item	Judgment Criteria	Classification
Chipping on Panel/Touch Panel	 <p style="text-align: center;">$a \leq 3.0\text{mm} \cdot b \leq 3.0\text{mm} \cdot c \leq t$ (Bottom glass thickness)</p>	MA
Scratch on Panel/Touch Panel *Note-2	1.BM: Ignored 2.Pixel area $W \leq 0.05\text{mm}$ or $L < 5\text{mm}$: Ignored $0.05\text{mm} < W \leq 0.1\text{mm}$ and $L \leq 5\text{mm}$: $N \leq 5$ $W > 0.1\text{mm}$ or $L > 5\text{mm}$: Not allowed	MI
Bubble or Dent on Panel/Touch Panel *Note-3	1.BM: Ignored 2.Pixel area $D \leq 0.2\text{mm}$: Ignored $0.2\text{mm} < D \leq 0.3\text{mm}$: $N \leq 5$ $D > 0.3\text{mm}$: Not allowed	MI
Panel/Touch Panel Crack	 <p style="text-align: center;">Not Allowed crack</p>	MA
Bezel Deformation	Obvious deformation is not allowed.	MI
Bezel Oxidation	Not allowed if it rusts continuously over 1 cm (It is out of warranty with rusted tin plate)	MI

Product Specification

	Model: GKTS80MNFG1E1	Rev. No.	Issued Date.	Page.
		C	2017, Sep.12	23 / 25

Bezel Scratch	$L \leq 20\text{mm}$, $W \leq 0.2$, $N \leq 3$	MI
Metal Squash Dent /Flange(Front Side)	$D(W) \leq 1, L \leq 3, N \leq 3;$	MI
B/L High Voltage Wire Denudation	Not allowed	MA
Polarizer flaw or leak out resin	Defect is defined as the active area.	MI
Outline Dimension	Must in Spec, refer to related product spec.	MI

9.2.2 Functional Inspection:

Item	Judgment Criteria			Classification
	Area(Note 1)	I	O	
Point Defect	Bright dot	Random	2	
		2 dots adjacent	0	0
		3 dots adjacent or more	0	0
	Dark dot	Random	3	
		2 dots adjacent	0	
		3 dots adjacent or more	0	0
	Total Dot Defect		5	
	Distance	Distance between Bright and Bright dot	$L \geq 5\text{mm}$	
		Distance between Bright and Dark dot	$L \geq 5\text{mm}$	
		Distance between Dark dot	$L \geq 5\text{mm}$	
(1)It is defined as Point Defect if defect area $> 0.5\text{dot}$ (2)It is ignored if defect area $\leq 0.5\text{dot}$ (3)Weak point defect will be defined as Bright Dot if it can be observed through ND filter 6%(Full Screen Black Inspection)				
Line Defect	Obvious vertical or horizontal line defect is not allowed.			MA
Mura or Leak	Not allowed if it can be observed through ND Filter 6%			MI
Foreign Material in spot shape *Note-3	Visible under : ND6% $D \leq 0.2\text{mm}$: Ignored/不計 $0.2\text{mm} < D \leq 0.5\text{mm}$: $N \leq 8$ $D > 0.5\text{mm}$: Not allowed/不允許			MI

Product Specification

	Model: GKTS80MNFG1E1	Rev. No.	Issued Date.	Page.
		C	2017, Sep.12	24 / 25

Foreign Material in line or spiral shape *Note-4	Visible under : ND6% $W \leq 0.05\text{mm}$ or $L \leq 6\text{mm}$: Ignored $0.05\text{mm} < W \leq 0.2\text{mm}$ and $L \leq 6\text{mm}$: $N \leq 8$ $W > 0.2\text{mm}$ or $L > 5\text{mm}$: Not allowed	MI
Display Function Abnormal	No Malfunction can be allowed	MA
Touch panel Malfunction *Note-5	No Malfunction can be allowed in AA area.	MA

Product Specification

	Model: GKTS80MNFG1E1	Rev. No.	Issued Date.	Page.
		C	2017, Sep.12	25 / 25

Note-1 : I/O Area Definition

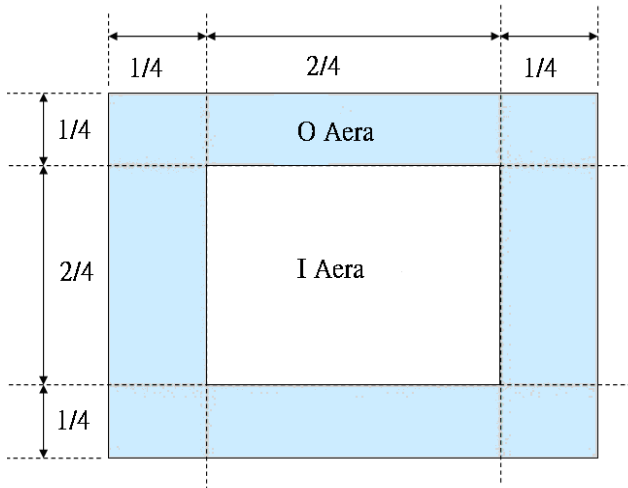

Note-2 : Polarizer Scratch

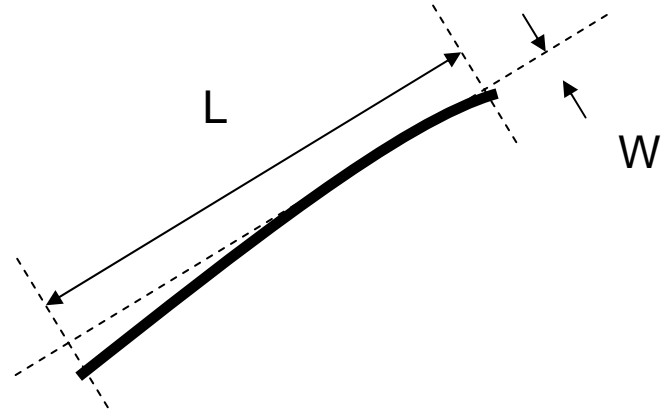

Note-3 : Spot Foreign Material
($W \geq L / 4$)

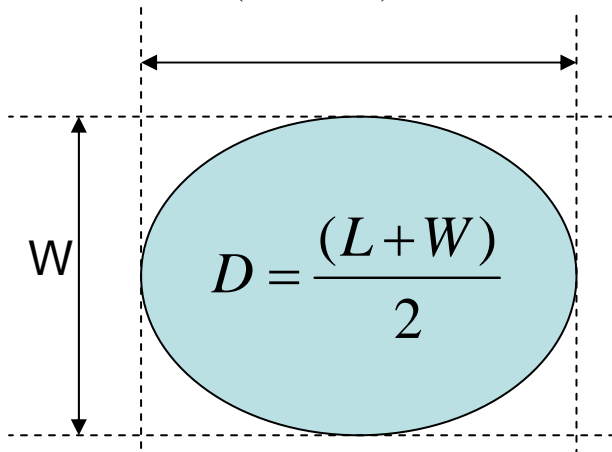

Note-4 : Line or Spiral Foreign Material
($W < L / 4$)

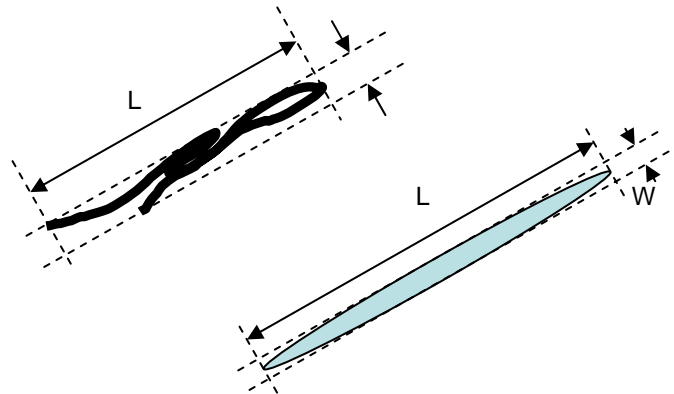

Note-5 : TP Inspection Area Definition

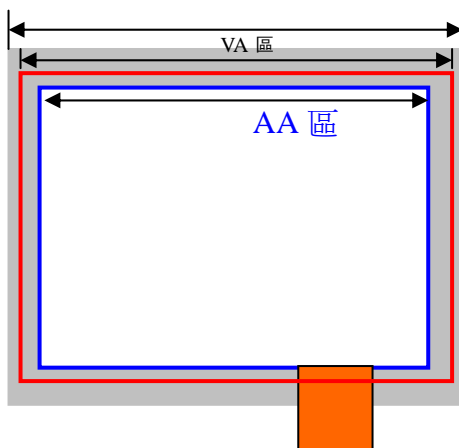

Note-5 : TP Inspection Area Definition

Our company network supports you worldwide with offices in Germany, Austria, Switzerland, the UK and the USA. For more information please contact:

Headquarters

Germany



FORTEC Elektronik AG

Lechwiesenstr. 9
86899 Landsberg am Lech

Phone: +49 8191 91172-0
E-Mail: sales@forteca.de
Internet: www.forteca.de

Fortec Group Members

Austria



FORTEC Elektronik AG

Office Vienna

Nuschinggasse 12
1230 Wien

Phone: +43 1 8673492-0
E-Mail: office@fortec.at
Internet: www.fortec.at

Germany



Distec GmbH

Augsburger Str. 2b
82110 Germering

Phone: +49 89 894363-0
E-Mail: info@distec.de
Internet: www.distec.de

Switzerland



ALTRAC AG

Bahnhofstraße 3
5436 Würenlos

Phone: +41 44 7446111
E-Mail: info@altrac.ch
Internet: www.altrac.ch

United Kingdom



Display Technology Ltd.

Osprey House, 1 Osprey Court
Hichingbrooke Business Park
Huntingdon, Cambridgeshire, PE29 6FN

Phone: +44 1480 411600
E-Mail: info@displaytechnology.co.uk
Internet: www.displaytechnology.co.uk

USA



Apollo Display Technologies, Corp.

87 Raynor Avenue,
Unit 1 Ronkonkoma,
NY 11779

Phone: +1 631 5804360
E-Mail: info@apolloDisplays.com
Internet: www.apolloDisplays.com